

Hydraulic fittings

Hydraulické koncovky

3

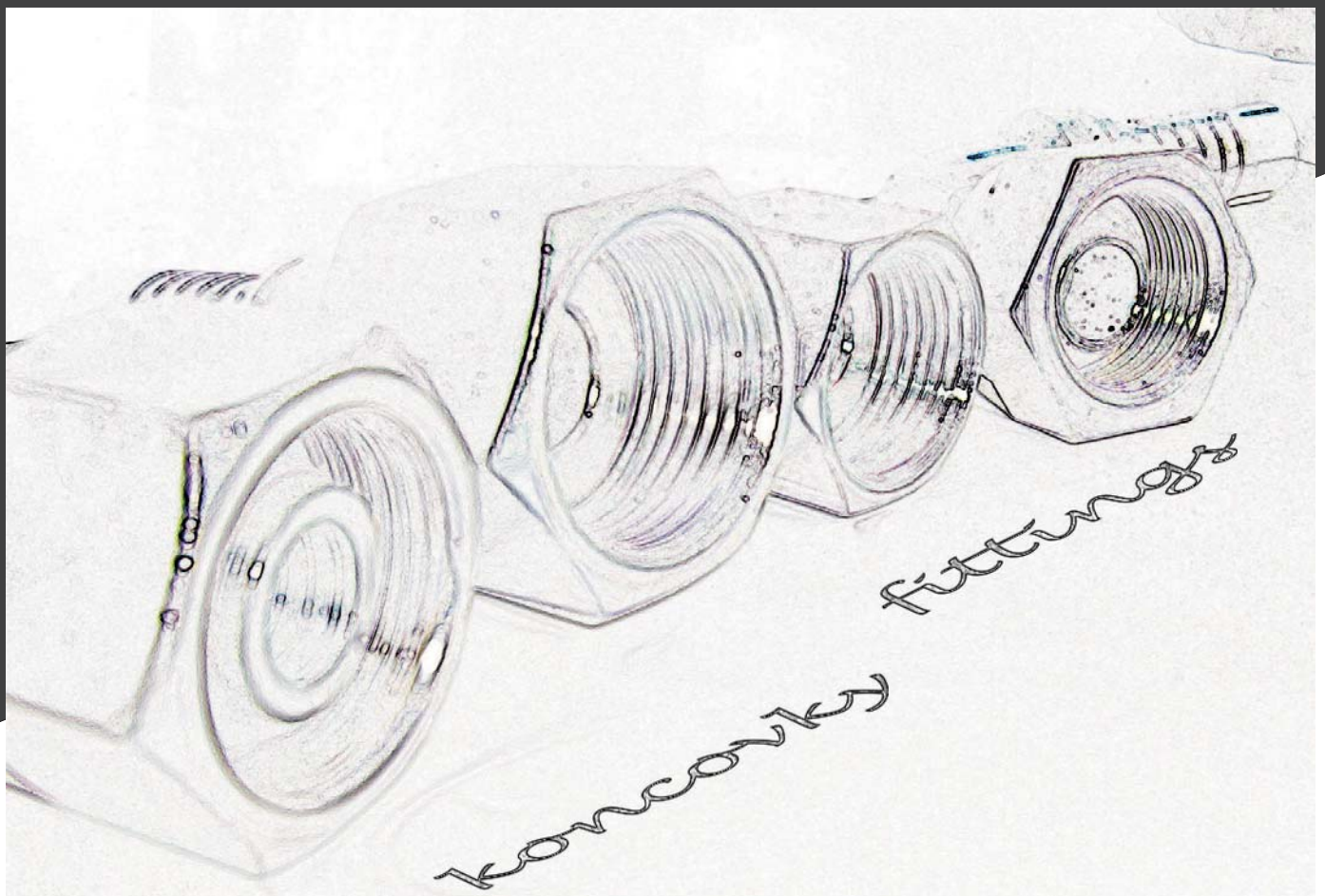

Obsah/Index

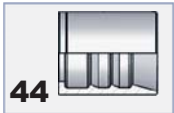

44
Orezávana/skive
EN853 1SN/1ST,
SAE100
R1AT, SAE R1A



44
Orezávana/skive
EN853 2SN/2ST,
SAE100
R2AT, SAE R2A



45
Orezávana/skive
EN856 4SP,
SAE100
R9R R10/R12



45
Orezávana/skive
EN 856 4SH



46
Bezorezávana
/no-skive
EN853 1SN,
SAE100 R1A



46
Bezorezávana
/no-skive
EN853 2SN,
SAE100 R2A

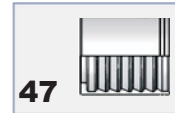

47
Bezorezávana
/no-skive
EN853 1SN/2SN,
SAE100 R1T/R2T

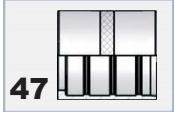

47
Bezorezávana
/no-skive
EN 853 1TE
SAE 100 R7 R8 R6

Ferrules
Objímky

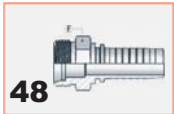

48
CEL, metric 24°
light s., ľahká r.

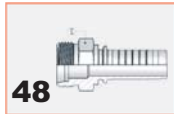

48
CES, metric 24°
heavy s., ťažká r.



49
DKOL metric 24°
L.T. s/with O-ring



49
DKOL45° metric 24°
L.T. s/with O-ring



50
DKOL90° metric 24°
L.T. s/with O-ring



50
DKOS, metric 24°
heavy s., ťažká r.



51
DKOS45° metric 24°
heavy s., ťažká r.



51
DKOS90° metric 24°
heavy s., ťažká r.



52
DKL, metric 24°
light s., ľahká r.



52
AGM metric 60°



53
DKM metric 60°



53
DKM45° metric 60°



54
DKM90° metric 60°



54
BEL BES metric
standpipe L.T./H.T.



55
BEL BES45° metric
standpipe L.T./H.T.



55
BEL BES90° metric
standpipe L.T./H.T.

DIN metric fittings (M)
DIN metrické koncovky

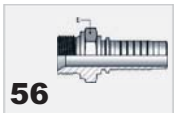

56
AGR, BSPP
male 60° BS 5200

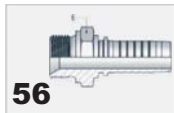

56
AGR-K, BSPT
male 60° BS 5200

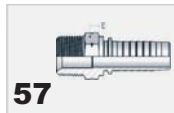

57
AGN, NPTF 60°



57
DKR, BSP 60°,
BS 5200



58
DKR 45°, BSP 60°,
BS 5200



58
DKR 90°, BSP 60°,
BS 5200



59
DKOR, BSP 60°,
BS 5200



59
DKOR 45°, BSP 60°
BS 5200



60
DKOR 90°, BSP 60°
BS 5200



60
AGR FF, BSP, flat
rovné č. BS 5200



61
DKR FF, BSP, flat
rovné č. BS 5200



61
DKR, BSP Compact
60° BS 5200

BSP fittings (G")
BSP koncovky

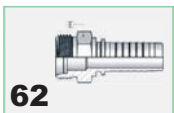

62
AGF French
metric 24°
millimetric type

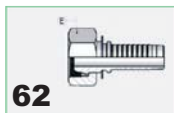

62
DKF French
metric 24°
millimetric type



63
DKF45 French
metric 24°
millimetric type



63
DKF90 French
metric 24°
millimetric type

French
Millimetric



64
AGJ, JIC 74°
SAE J516/J514



64
DKJ, JIC 74°
SAE J516/J514



65
DKJ45°, JIC 74°
SAE J516/J514



65
DKJ90°, JIC 74°
SAE J516/J514



66
ORS SAE J1453

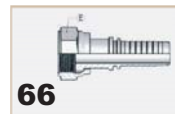

66
ORFS SAE J516
J1453



67
ORFS45° SAE
J516 J1453

SAE Fittings
SEA Koncovky

Obsah/Index



67
ORFS90° SAE
J516 J1453



68
ORFS90° Long
SAE J516/J1453



68
SFL 3000psi
SAE J518 code 61



69
SFL45 3000psi
SAE J518 code 61



69
SFL90 3000psi
SAE J518 code 61



70
SFS 6000psi
SAE J518 code 62



70
SFS45 6000psi
SAE J518 code 62



71
SFL90 6000psi
SAE J518 code 62



71
SUPERCAT



72
SUPERCAT45



72
SUPERCAT90

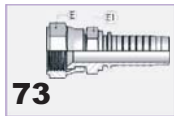

73
JIS metric 60°
cone JIS B8362
KOMATSU



73
JIS BSP 60°
cone JIS B8364
TOYOTA



74
JIS BSP 60°
cone JIS B8362
NISSAN

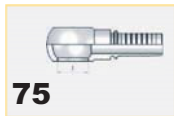

75
Metric Banjo/oko
DIN 7642



75
Metric bolt/
skrutka DIN 7643



76
BSP Banjo/oko



76
BSP bolt/
skrutka



76
Metric bolt/
skrutka DIN 7643



76
BSP bolt/
skrutka

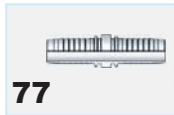

77
Spojka
Double insert



77
FK (Karcher)



78
STECK
banská/mining



78
SAE 3000psi
Split flan./polprir.



79
SAE 6000psi
Split flan./polprir.



80
Orezavana/skive
4SP 4SH R12
R13 R15



80
Orezavana/skive
R13 R15



81
CES metric24°
heavy s., těžká r.
interlock



81
DKOS metric24°
heavy s., těžká r.
interlock



82
DKOS45° metric24°
heavy s., těžká r.
interlock



82
DKOS90° metric24°
heavy s., těžká r.
interlock



83
AGR, BSPP
male 60° BS 5200
interlock

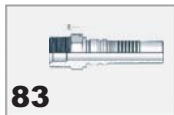

83
AGR-K BSPT
male 60° BS 5200
interlock



84
DKOR BSP 60°
BS 5200
interlock

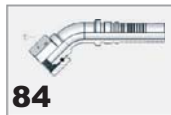

84
DKOR45 BSP 60°
BS 5200
interlock



85
DKOR90 BSP 60°
BS 5200
interlock



85
AGJ JIC 74°
SAE J516/J514
interlock

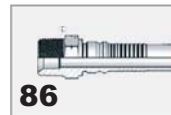

86
AGN NPTF 60°
interlock



86
DKJ JIC 74°
SAE J516/J514
interlock



87
DKJ45 JIC 74°
SAE J516/J514
interlock



87
DKJ90 JIC 74°
SAE J516/J514
interlock



88
ORS SAE J1453
interlock



88
ORFS SAE J516
J1453
interlock



89
ORFS45 SAE J516
J1453
interlock



89
ORFS90 SAE J516
J1453
interlock



90
SFL 3000psi
SAE J518 code 61
interlock



90
SFL45 3000psi
SAE J518 code 61
interlock



91
SFL90 3000psi
SAE J518 code 61
interlock



91
SFS 6000psi
SAE J518 code 62
interlock



92
SFS45 6000psi
SAE J518 code 62
interlock



92
SFS90 6000psi
SAE J518 code 62
interlock



93
SUPERCAT
interlock



93
SUPERCAT45
interlock

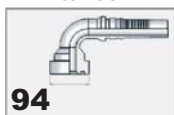

94
SUPERCAT90
interlock

SAE Fittings
SEA Koncovky

JIS
fittings

Banjo
bolt

Accessories
Príslušenstvo

INTERLOCK fittings
INTERLOCK koncovky



Objimka pre orezované hadice DIN EN 853 1SN/1ST, SAE 100 R1AT, SAE R1A
Skive ferrule for DIN EN 853 1SN/1ST, SAE 100 R1AT, SAE R1A

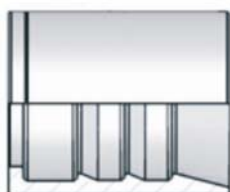

0001 1SN/1ST	Hadica / Hose						Označenie
Kód/Code	inch	mm	Size				Description
000106	1/4"	6	-4				OB 1S DN06
000108	5/16"	8	-5				OB 1S DN08
000110	3/8"	10	-6				OB 1S DN10
000113	1/2"	13	-8				OB 1S DN13
000116	5/8"	16	-10				OB 1S DN16
000120	3/4"	20	-12				OB 1S DN20
000125	1"	25	-16				OB 1S DN25
000132	1 1/4"	32	-20				OB 1S DN32
000140	1 1/2"	40	-24				OB 1S DN40
000150	2"	50	-32				OB 1S DN50

1SN/1ST
skive
0001

Koncovky_fittings

Hadice_hoses

Ochrany_protections

Objimka pre orezované hadice DIN EN 853 2SN/2ST, SAE 100 R2AT, SAE R2A
Skive ferrule for DIN EN 853 2SN/2ST, SAE 100 R2AT, SAE R2A

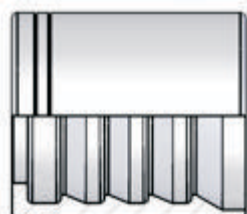
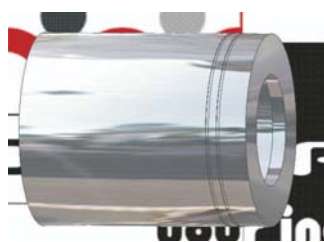

0002 2SN/2ST	Hadica / Hose						Označenie
Kód/Code	inch	mm	Size				Description
000206	1/4"	6	-4				OB 2S DN06
000208	5/16"	8	-5				OB 2S DN08
000210	3/8"	10	-6				OB 2S DN10
000213	1/2"	13	-8				OB 2S DN13
000216	5/8"	16	-10				OB 2S DN16
000220	3/4"	19	-12				OB 2S DN20
000225	1"	25	-16				OB 2S DN25
000232	1 1/4"	32	-20				OB 2S DN32
000240	1 1/2"	40	-24				OB 2S DN40
000250	2"	50	-32				OB 2S DN50

2SN/2ST
skive
0002

Note:



Objimka pre orezované hadice DIN EN 856 4SP, SAE 100 R9R/R10/R12
Skive ferrule for DIN EN 856 4SP, SAE 100 R9R/R10/R12

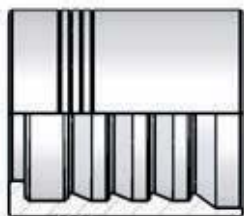

0003 4SP Kód/Code	Hadica / Hose			Size				Označenie
	inch	mm						Description
000306	1/4"	6		-4				OB 4SP DN06
000308	5/16"	8		-5				OB 4SP DN08
000310	3/8"	10		-6				OB 4SP DN10
000313	1/2"	13		-8				OB 4SP DN13
000316	5/8"	16		-10				OB 4SP DN16
000320	3/4"	19		-12				OB 4SP DN20
000325	1"	25		-16				OB 4SP DN25
000332	1 1/4"	32		-20				OB 4SP DN32
000340	1 1/2"	40		-24				OB 4SP DN40
000350	2"	50		-32				OB 4SP DN50

4SP
skive
0003

Koncovky_fittings

Hadice_hoses

Ochrany_protections

Objimka pre orezované hadice typ DIN EN 856 4SH
Skive ferrule for DIN EN 856 4SH

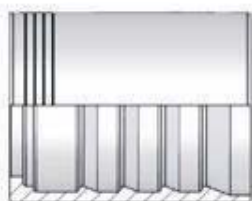

0004 4SH Kód/Code	Hadica / Hose			Size				Označenie
	inch	mm						Description
000406	1/4"	6		-4				OB 4SH DN06
000408	5/16"	8		-5				OB 4SH DN08
000410	3/8"	10		-6				OB 4SH DN10
000413	1/2"	13		-8				OB 4SH DN13
000416	5/8"	16		-10				OB 4SH DN16
000420	3/4"	19		-12				OB 4SH DN20
000425	1"	25		-16				OB 4SH DN25
000432	1 1/4"	32		-20				OB 4SH DN32
000440	1 1/2"	40		-24				OB 4SH DN40
000450	2"	50		-32				OB 4SH DN50

4SH
skive
0004

Note:



Objimka pre neorezované hadice DIN EN 853 1SN, SAE 100 R1T No skive ferrule for DIN EN 853 1SN, SAE 100 R1T

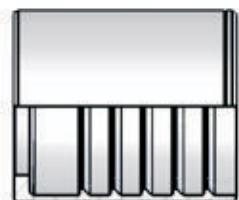
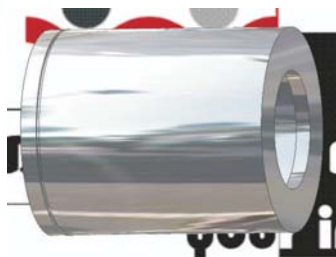

0006 1SB Kód/Code	Hadica / Hose			Označenie Description
	inch	mm	Size	
000606	1/4"	6	-4	OB 1SB DN06
000608	5/16"	8	-5	OB 1SB DN08
000610	3/8"	10	-6	OB 1SB DN10
000613	1/2"	13	-8	OB 1SB DN13
000616	5/8"	16	-10	OB 1SB DN16
000620	3/4"	19	-12	OB 1SB DN20
000625	1"	25	-16	OB 1SB DN25
000632	1 1/4"	32	-20	OB 1SB DN32
000640	1 1/2"	40	-24	OB 1SB DN40
000650	2"	50	-32	OB 1SB DN50

1SN
no skive
0006

Koncovky_fittings

Hadice_hoses

Ochrany_protections

Objimka pre neorezované hadice DIN EN 853 2SN, SAE 100 R2T No skive ferrule for DIN EN 853 2SN, SAE 100 R2T

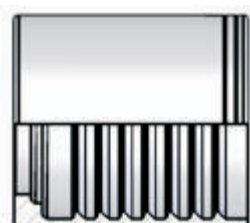
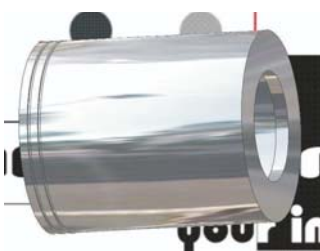

0007 2SB Kód/Code	Hadica / Hose			Označenie Description
	inch	mm	Size	
000706	1/4"	6	-4	OB 2SB DN06
000708	5/16"	8	-5	OB 2SB DN08
000710	3/8"	10	-6	OB 2SB DN10
000713	1/2"	13	-8	OB 2SB DN13
000716	5/8"	16	-10	OB 2SB DN16
000720	3/4"	19	-12	OB 2SB DN20
000725	1"	25	-16	OB 2SB DN25
000732	1 1/4"	32	-20	OB 2SB DN32
000740	1 1/2"	40	-24	OB 2SB DN40
000750	2"	50	-32	OB 2SB DN50

2SN
no skive
0007

Note:



Objimka pre neorezované hadice DIN EN 853 1SN/2SN, SAE 100 R1T/R2T
No skive ferrule for DIN EN 853 1SN/2SN, SAE 100 R1T /R2T

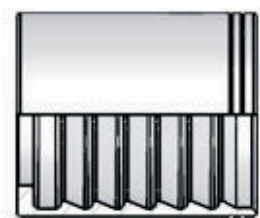

0005 1B2S Kód/Code	Hadica / Hose						Označenie
	inch	mm	Size				Description
000506	1/4"	6	-4				OB 1B2S DN06
000508	5/16"	8	-5				OB 1B2S DN08
000510	3/8"	10	-6				OB 1B2S DN10
000513	1/2"	13	-8				OB 1B2S DN13
000516	5/8"	16	-10				OB 1B2S DN16
000520	3/4"	19	-12				OB 1B2S DN20
000525	1"	25	-16				OB 1B2S DN25
000532	1 1/4"	32	-20				OB 1B2S DN32
000540	1 1/2"	40	-24				OB 1B2S DN40
000550	2"	50	-32				OB 1B2S DN50

1SN/2SN
no skive
0005

Koncovky_fittings

Hadice_hoses

Ochrany_protections

Objimka pre neorezované hadice EN 853 1TE/SAE 100 R7 R8 R6 (termoplastické hadice)
No skive ferrule for EN 853 1TE/SAE 100 R7 R8 R6 (thermoplastic hoses)

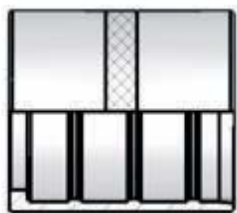

0008 R8R7 Kód/Code	Hadica / Hose						Označenie
	inch	mm	Size				Description
000805	3/16"	5	-3				OB 7RB DN05
000806	1/4"	6	-4				OB 7RB DN06
000808	5/16"	8	-5				OB 7RB DN08
000810	3/8"	10	-6				OB 7RB DN10
000813	1/2"	13	-8				OB 7RB DN13
000816	5/8"	16	-10				OB 7RB DN16
000820	3/4"	19	-12				OB 7RB DN20
000825	1"	25	-16				OB 7RB DN25

R7/8/6
no skive
0007

for PTFE hoses please see PTFE catalogue/section
 pre PTFE hadice pozrite PTFE katalóg/sekciiu

for others ferrules please contact our sales department
 pre iné typy objímok kontaktujte naše predajné oddelenie

Note:



CEL, metrický závit vonkajší 24° kužel, ľahká rada, priama
CEL, male metric 24° cone seat, light series L.T., straight

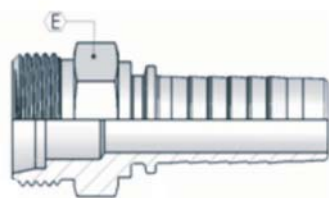
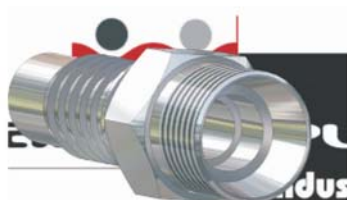

0103 CEL	Hadica / Hose			Závit	TR DIN	Kľúč E	Označenie
Kód/Code	inch	DN	Size	Thread	DIN PIPE	Hex E	Description
01030612	1/4"	6	-4	M12x1,5	6	14	CEL DN06 M12x1,5
01030614	1/4"	6	-4	M14x1,5	8	14	CEL DN06 M14x1,5
01030616	1/4"	6	-4	M16x1,5	10	17	CEL DN06 M16x1,5
01030618	1/4"	6	-4	M18x1,5	12	19	CEL DN06 M18x1,5
01030816	5/16"	8	-5	M16x1,5	10	17	CEL DN08 M16x1,5
01030818	5/16"	8	-5	M18x1,5	12	19	CEL DN08 M18x1,5
01031016	3/8"	10	-6	M16x1,5	10	17	CEL DN10 M16x1,5
01031018	3/8"	10	-6	M18x1,5	12	19	CEL DN10 M18x1,5
01031020	3/8"	10	-6	M20x1,5	12	22	CEL DN10 M20x1,5
01031022	3/8"	10	-6	M22x1,5	15	24	CEL DN10 M22x1,5
01031222	1/2"	13	-8	M22x1,5	15	24	CEL DN12 M22x1,5
01031226	1/2"	13	-8	M26x1,5	18	27	CEL DN12 M26x1,5
01031626	5/8"	16	-10	M26x1,5	18	27	CEL DN16 M26x1,5
01031627	5/8"	16	-10	M27x1,5	18	27	CEL DN16 M27x1,5
010316272	5/8"	16	-10	M27x2	18	27	CEL DN16 M27x2
01032030	3/4"	19	-12	M30x1,5	22	32	CEL DN20 M30x1,5
010320302	3/4"	19	-12	M30x2	22	32	CEL DN20 M30x2
01032033	3/4"	19	-12	M33x1,5	28	36	CEL DN20 M33x1,5
010320332	3/4"	19	-12	M33x2	22	36	CEL DN20 M33x2
01032536	1"	25	-16	M36x2	28	36	CEL DN25 M36x2
01032539	1"	25	-16	M39x1,5	28	46	CEL DN25 M39x1,5
01033245	1 1/4"	32	-20	M45x2	35	46	CEL DN32 M45x2
01034052	1 1/2"	38	-24	M52x2	42	55	CEL DN40 M52x2

Koncovky_fittings

Hadice_hoses

Ochrany_protections

CEL
0103

CES priame, metrický závit vonkajší 24° kužel, ťažká rada
CES straight, male metric 24° cone seat, heavy series H.T.

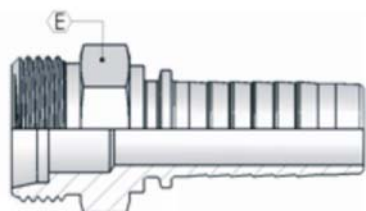
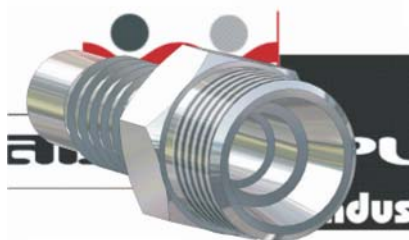

0123 CES	Hadica / Hose			Závit	TR DIN	Kľúč E	Označenie
Kód/Code	inch	DN	Size	Thread	DIN PIPE	Hex E	Description
01230614	1/4"	6	-4	M14x1,5	6	14	CES DN06 M14x1,5
01230616	1/4"	6	-4	M16x1,5	8	17	CES DN06 M16x1,5
01230618	1/4"	6	-4	M18x1,5	10	19	CES DN06 M18x1,5
01230620	1/4"	6	-4	M20x1,5	12	22	CES DN06 M20x1,5
01230818	5/16"	8	-5	M18x1,5	10	19	CES DN08 M18x1,5
01230820	5/16"	8	-5	M20x1,5	12	22	CES DN08 M20x1,5
01231018	3/8"	10	-6	M18x1,5	10	19	CES DN10 M18x1,5
01231020	3/8"	10	-6	M20x1,5	12	22	CES DN10 M20x1,5
01231022	3/8"	10	-6	M22x1,5	14	24	CES DN10 M22x1,5
01231222	1/2"	13	-8	M22x1,5	14	24	CES DN12 M22x1,5
01231224	1/2"	13	-8	M24x1,5	16	27	CES DN12 M24x1,5
01231630	5/8"	16	-10	M30x2	20	32	CES DN16 M30x2
01232030	3/4"	19	-12	M30x2	20	32	CES DN20 M30x2
01232036	3/4"	19	-12	M36x2	25	36	CES DN20 M36x2
01232536	1"	25	-16	M36x2	25	36	CES DN25 M36x2
01232542	1"	25	-16	M42x2	30	46	CES DN25 M42x2
01233242	1 1/4"	32	-20	M42x2	30	46	CES DN32 M42x2
01233252	1 1/4"	32	-20	M52x2	38	55	CES DN32 M52x2
01234052	1 1/2"	38	-24	M52x2	38	55	CES DN40 M52x2

CES
0123

Note:



DKOL priame, metrický závit vnútorný 24° kužel', ľahká rada s O-krúžkom
DKOL straight, female metric 24° cone seat, light series L.T. with O-ring

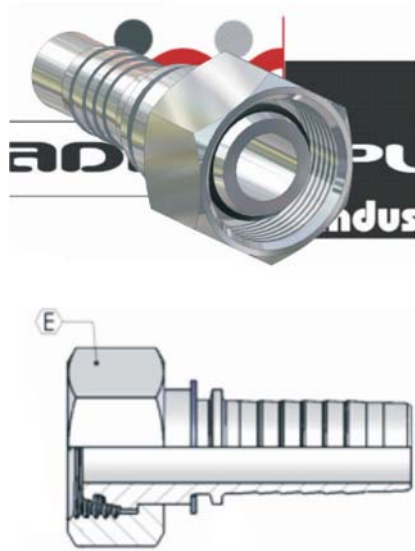

0110 DKOL	Hadica / Hose			Závit	TR DIN	Kľúč E	Označenie
Kód/Code	inch	DN	Size	Thread	DIN PIPE	Hex E	Description
01100612	1/4"	6	-4	M12x1,5	6	14	DKOL DN06 M12x1,5
01100614	1/4"	6	-4	M14x1,5	8	17	DKOL DN06 M14x1,5
01100616	1/4"	6	-4	M16x1,5	10	19	DKOL DN06 M16x1,5
01100618	1/4"	6	-4	M18x1,5	12	22	DKOL DN06 M18x1,5
01100816	5/16"	8	-5	M16x1,5	10	19	DKOL DN08 M16x1,5
01100818	5/16"	8	-5	M18x1,5	12	22	DKOL DN08 M18x1,5
01101016	3/8"	10	-6	M16x1,5	10	19	DKOL DN10 M16x1,5
01101018	3/8"	10	-6	M18x1,5	12	22	DKOL DN10 M18x1,5
01101020	3/8"	10	-6	M20x1,5	12	24	DKOL DN10 M20x1,5
01101022	3/8"	10	-6	M22x1,5	15	27	DKOL DN10 M22x1,5
01101222	1/2"	13	-8	M22x1,5	15	27	DKOL DN12 M22x1,5
01101226	1/2"	13	-8	M26x1,5	18	32	DKOL DN12 M26x1,5
01101626	5/8"	16	-10	M26x1,5	18	32	DKOL DN16 M26x1,5
01101627	5/8"	16	-10	M27x1,5	18	32	DKOL DN16 M27x1,5
011016272	5/8"	16	-10	M27x2	18	32	DKOL DN16 M27x2
01102030	3/4"	19	-12	M30x1,5	22	36	DKOL DN20 M30x1,5
011020302	3/4"	19	-12	M30x2	22	36	DKOL DN20 M30x2
01102033	3/4"	19	-12	M33x1,5	28	41	DKOL DN20 M33x1,5
011020332	3/4"	19	-12	M33x2	22	41	DKOL DN20 M33x2
01102536	1"	25	-16	M36x2	28	41	DKOL DN25 M36x2
01102539	1"	25	-16	M39x1,5	28	46	DKOL DN25 M39x1,5
01103245	1 1/4"	32	-20	M45x2	35	50	DKOL DN32 M45x2
01104052	1 1/2"	38	-24	M52x2	42	60	DKOL DN40 M52x2

**DKOL
0110**

Koncovky_fittings

Hadice_hoses

Ochrany_protections

DKOL 45° koleno, metrický závit vnútorný 24° kužel', ľahká rada s O-krúžkom
DKOL 45° elbow, female metric 24° cone seat, light series L.T. with O-ring

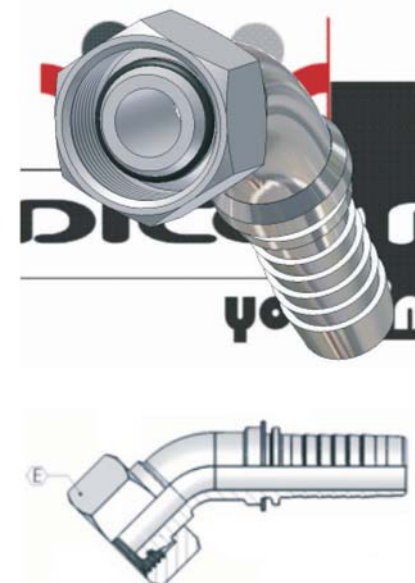

0114 DKOL45	Hadica / Hose			Závit	TR DIN	Kľúč E	Označenie
Kód/Code	inch	DN	Size	Thread	DIN PIPE	Hex E	Description
01140612	1/4"	6	-4	M12x1,5	6	14	DKOL 45 DN06 M12x1,5
01140614	1/4"	6	-4	M14x1,5	8	17	DKOL 45 DN06 M14x1,5
01140616	1/4"	6	-4	M16x1,5	10	19	DKOL 45 DN06 M16x1,5
01140618	1/4"	6	-4	M18x1,5	12	22	DKOL 45 DN06 M18x1,5
01140816	5/16"	8	-5	M16x1,5	10	19	DKOL 45 DN08 M16x1,5
01140818	5/16"	8	-5	M18x1,5	12	22	DKOL 45 DN08 M18x1,5
01141016	3/8"	10	-6	M16x1,5	10	19	DKOL 45 DN10 M16x1,5
01141018	3/8"	10	-6	M18x1,5	12	22	DKOL 45 DN10 M18x1,5
01141020	3/8"	10	-6	M20x1,5	12	24	DKOL 45 DN10 M20x1,5
01141022	3/8"	10	-6	M22x1,5	15	27	DKOL 45 DN10 M22x1,5
01141222	1/2"	13	-8	M22x1,5	15	27	DKOL 45 DN12 M22x1,5
01141226	1/2"	13	-8	M26x1,5	18	32	DKOL 45 DN12 M26x1,5
01141626	5/8"	16	-10	M26x1,5	18	32	DKOL 45 DN16 M26x1,5
01141627	5/8"	16	-10	M27x1,5	18	32	DKOL 45 DN16 M27x1,5
011416272	5/8"	16	-10	M27x2	18	32	DKOL 45 DN16 M27x2
01142030	3/4"	19	-12	M30x1,5	22	36	DKOL 45 DN20 M30x1,5
011420302	3/4"	19	-12	M30x2	22	36	DKOL 45 DN20 M30x2
01142033	3/4"	19	-12	M33x1,5	28	41	DKOL 45 DN20 M33x1,5
011420332	3/4"	19	-12	M33x2	22	41	DKOL 45 DN20 M33x2
01142536	1"	25	-16	M36x2	28	41	DKOL 45 DN25 M36x2
01142539	1"	25	-16	M39x1,5	28	46	DKOL 45 DN25 M39x1,5
01143245	1 1/4"	32	-20	M45x2	35	50	DKOL 45 DN32 M45x2
01144052	1 1/2"	38	-24	M52x2	42	60	DKOL 45 DN40 M52x2

**DKOL 45
0114**

Note:



DKOL 90° koleno, metrický závit vnútorný 24° kužel', ľahká rada s O-kružkom
DKOL 90° elbow, female metric 24° cone seat, light series L.T. with O-ring

let's work us



0119 DKOL90	Hadica / Hose			Závit	TR DIN	Kľúč E	Označenie
Kód/Code	inch	DN	Size	Thread	DIN PIPE	Hex E	Description
01190612	1/4"	6	-4	M12x1,5	6	14	DKOL 90 DN06 M12x1,5
01190614	1/4"	6	-4	M14x1,5	8	17	DKOL 90 DN06 M14x1,5
01190616	1/4"	6	-4	M16x1,5	10	19	DKOL 90 DN06 M16x1,5
01190618	1/4"	6	-4	M18x1,5	12	22	DKOL 90 DN06 M18x1,5
01190816	5/16"	8	-5	M16x1,5	10	19	DKOL 90 DN08 M16x1,5
01190818	5/16"	8	-5	M18x1,5	12	22	DKOL 90 DN08 M18x1,5
01191016	3/8"	10	-6	M16x1,5	10	19	DKOL 90 DN10 M16x1,5
01191018	3/8"	10	-6	M18x1,5	12	22	DKOL 90 DN10 M18x1,5
01191020	3/8"	10	-6	M20x1,5	12	24	DKOL 90 DN10 M20x1,5
01191022	3/8"	10	-6	M22x1,5	15	27	DKOL 90 DN10 M22x1,5
01191222	1/2"	13	-8	M22x1,5	15	27	DKOL 90 DN12 M22x1,5
01191226	1/2"	13	-8	M26x1,5	18	32	DKOL 90 DN12 M26x1,5
01191626	5/8"	16	-10	M26x1,5	18	32	DKOL 90 DN16 M26x1,5
01191627	5/8"	16	-10	M27x1,5	18	32	DKOL 90 DN16 M27x1,5
011916272	5/8"	16	-10	M27x2	18	32	DKOL 90 DN16 M27x2
01192030	3/4"	19	-12	M30x1,5	22	36	DKOL 90 DN20 M30x1,5
011920302	3/4"	19	-12	M30x2	22	36	DKOL 90 DN20 M30x2
01192033	3/4"	19	-12	M33x1,5	28	41	DKOL 90 DN20 M33x1,5
011920332	3/4"	19	-12	M33x2	22	41	DKOL 90 DN20 M33x2
01192536	1"	25	-16	M36x2	28	41	DKOL 90 DN25 M36x2
01192539	1"	25	-16	M39x1,5	28	46	DKOL 90 DN25 M39x1,5
01193245	1 1/4"	32	-20	M45x2	35	50	DKOL 90 DN32 M45x2
01194052	1 1/2"	38	-24	M52x2	42	60	DKOL 90 DN40 M52x2

**DKOL 90
0119**

Koncovky_fittings

Hadice_hoses

Ochrany_protections

DKOS priame, metrický závit vnútorný 24° kužel', ťažká rada
DKOS straight, female metric 24° cone seat, heavy series H.T.

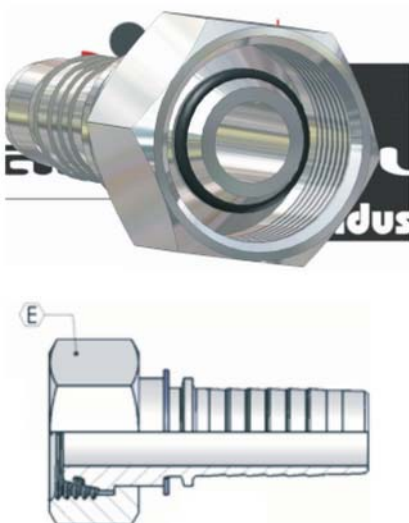

0120 DKOS	Hadica / Hose			Závit	TR DIN	Kľúč E	Označenie
Kód/Code	inch	DN	Size	Thread	DIN PIPE	Hex E	Description
01200614	1/4"	6	-4	M14x1,5	6	17	DKOS DN06 M14x1,5
01200616	1/4"	6	-4	M16x1,5	8	19	DKOS DN06 M16x1,5
01200618	1/4"	6	-4	M18x1,5	10	22	DKOS DN06 M18x1,5
01200620	1/4"	6	-4	M20x1,5	12	24	DKOS DN06 M20x1,5
01200818	5/16"	8	-5	M18x1,5	10	22	DKOS DN08 M18x1,5
01200820	5/16"	8	-5	M20x1,5	12	24	DKOS DN08 M20x1,5
01201018	3/8"	10	-6	M18x1,5	10	22	DKOS DN10 M18x1,5
01201020	3/8"	10	-6	M20x1,5	12	24	DKOS DN10 M20x1,5
01201022	3/8"	10	-6	M22x1,5	14	27	DKOS DN10 M22x1,5
01201222	1/2"	13	-8	M22x1,5	14	27	DKOS DN12 M22x1,5
01201224	1/2"	13	-8	M24x1,5	16	30	DKOS DN12 M24x1,5
01201630	5/8"	16	-10	M30x2	20	36	DKOS DN16 M30x2
01202030	3/4"	19	-12	M30x2	20	36	DKOS DN20 M30x2
01202036	3/4"	19	-12	M36x2	25	46	DKOS DN20 M36x2
01202536	1"	25	-16	M36x2	25	46	DKOS DN25 M36x2
01202542	1"	25	-16	M42x2	30	50	DKOS DN25 M42x2
01203242	1 1/4"	32	-20	M42x2	30	50	DKOS DN32 M42x2
01203252	1 1/4"	32	-20	M52x2	38	60	DKOS DN32 M52x2
01204052	1 1/2"	38	-24	M52x2	38	60	DKOS DN40 M52x2

**DKOS
0120**

Note:



DKOS 45° koleno, metrický závit vnútorný 24° kužel', ťažka rada s O-krúžkom
DKOS 45° elbow, female metric 24° cone seat, heavy series H.T. with O-ring

let's work us

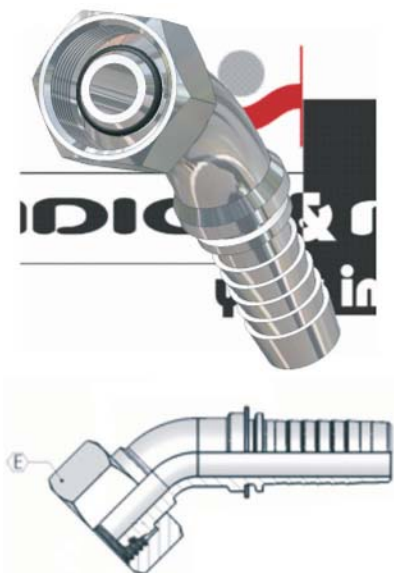

0124 DKOS45	Hadica / Hose		Závit	TR DIN	Klíúč E	Označenie	
Kód/Code	inch	mm	Size	Thread	DIN PIPE	Hex E	Description
01240614	1/4"	6	-4	M14x1,5	6	17	DKOS 45 DN06 M14x1,5
01240616	1/4"	6	-4	M16x1,5	8	19	DKOS 45 DN06 M16x1,5
01240618	1/4"	6	-4	M18x1,5	10	22	DKOS 45 DN06 M18x1,5
01240620	1/4"	6	-4	M20x1,5	12	24	DKOS 45 DN06 M20x1,5
01240818	5/16"	8	-5	M18x1,5	10	22	DKOS 45 DN08 M18x1,5
01240820	5/16"	8	-5	M20x1,5	12	24	DKOS 45 DN08 M20x1,5
01241018	3/8"	10	-6	M18x1,5	10	22	DKOS 45 DN10 M18x1,5
01241020	3/8"	10	-6	M20x1,5	12	24	DKOS 45 DN10 M20x1,5
01241022	3/8"	10	-6	M22x1,5	14	27	DKOS 45 DN10 M22x1,5
01241222	1/2"	13	-8	M22x1,5	14	27	DKOS 45 DN12 M22x1,5
01241224	1/2"	13	-8	M24x1,5	16	30	DKOS 45 DN12 M24x1,5
01241630	5/8"	16	-10	M30x2	20	36	DKOS 45 DN16 M30x2
01242030	3/4"	19	-12	M30x2	20	36	DKOS 45 DN20 M30x2
01242036	3/4"	19	-12	M36x2	25	46	DKOS 45 DN20 M36x2
01242536	1"	25	-16	M36x2	25	46	DKOS 45 DN25 M36x2
01242542	1"	25	-16	M42x2	30	50	DKOS 45 DN25 M42x2
01243242	1 1/4"	32	-20	M42x2	30	50	DKOS 45 DN32 M42x2
01243252	1 1/4"	32	-20	M52x2	38	60	DKOS 45 DN32 M52x2
01244052	1 1/2"	38	-24	M52x2	38	60	DKOS 45 DN40 M52x2

**DKOS 45°
0124**

Koncovky_fittings

Hadice_hoses

Ochrany_protections

DKOS 90° koleno, metrický závit vnútorný 24° kužel', ťažka rada s O-krúžkom
DKOS 90° elbow, female metric 24° cone seat, heavy series H.T. with O-ring



0129 DKOS90	Hadica / Hose		Závit	TR DIN	Klíúč E	Označenie	
Kód/Code	inch	mm	Size	Thread	DIN PIPE	Hex E	Description
01290614	1/4"	6	-4	M14x1,5	6	17	DKOS 90 DN06 M14x1,5
01290616	1/4"	6	-4	M16x1,5	8	19	DKOS 90 DN06 M16x1,5
01290618	1/4"	6	-4	M18x1,5	10	22	DKOS 90 DN06 M18x1,5
01290620	1/4"	6	-4	M20x1,5	12	24	DKOS 90 DN06 M20x1,5
01290818	5/16"	8	-5	M18x1,5	10	22	DKOS 90 DN08 M18x1,5
01290820	5/16"	8	-5	M20x1,5	12	24	DKOS 90 DN08 M20x1,5
01291018	3/8"	10	-6	M18x1,5	10	22	DKOS 90 DN10 M18x1,5
01291020	3/8"	10	-6	M20x1,5	12	24	DKOS 90 DN10 M20x1,5
01291022	3/8"	10	-6	M22x1,5	14	27	DKOS 90 DN10 M22x1,5
01291222	1/2"	13	-8	M22x1,5	14	27	DKOS 90 DN12 M22x1,5
01291224	1/2"	13	-8	M24x1,5	16	30	DKOS 90 DN12 M24x1,5
01291630	5/8"	16	-10	M30x2	20	36	DKOS 90 DN16 M30x2
01292030	3/4"	19	-12	M30x2	20	36	DKOS 90 DN20 M30x2
01292036	3/4"	19	-12	M36x2	25	46	DKOS 90 DN20 M36x2
01292536	1"	25	-16	M36x2	25	46	DKOS 90 DN25 M36x2
01292542	1"	25	-16	M42x2	30	50	DKOS 90 DN25 M42x2
01293242	1 1/4"	32	-20	M42x2	30	50	DKOS 90 DN32 M42x2
01293252	1 1/4"	32	-20	M52x2	38	60	DKOS 90 DN32 M52x2
01294052	1 1/2"	38	-24	M52x2	38	60	DKOS 90 DN40 M52x2

**DKOS 90°
0129**

Note:



DKL, metrický závit vnútorný 24° kužel', ľahká rada, priama
DKL, female metric 24° cone seat, light series L.T., straight

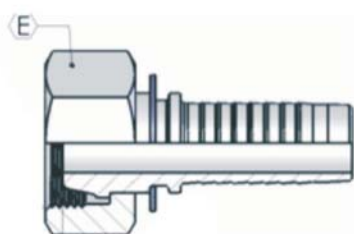
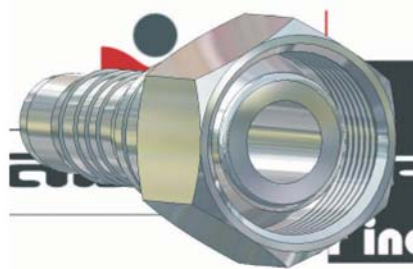

0100 DKL	Hadica / Hose			Závit	TR DIN	Kľúč E	Označenie
Kód/Code	inch	DN	Size	Thread	DIN PIPE	Hex E	Description
01000612	1/4"	6	-4	M12x1,5	6	14	DKL DN06 M12x1,5
01000614	1/4"	6	-4	M14x1,5	8	17	DKL DN06 M14x1,5
01000616	1/4"	6	-4	M16x1,5	10	19	DKL DN06 M16x1,5
01000618	1/4"	6	-4	M18x1,5	12	22	DKL DN06 M18x1,5
01000816	5/16"	8	-5	M16x1,5	10	19	DKL DN08 M16x1,5
01000818	5/16"	8	-5	M18x1,5	12	22	DKL DN08 M18x1,5
01001016	3/8"	10	-6	M16x1,5	10	19	DKL DN10 M16x1,5
01001018	3/8"	10	-6	M18x1,5	12	22	DKL DN10 M18x1,5
01001020	3/8"	10	-6	M20x1,5	12	24	DKL DN10 M20x1,5
01001022	3/8"	10	-6	M22x1,5	15	27	DKL DN10 M22x1,5
01001222	1/2"	13	-8	M22x1,5	15	27	DKL DN12 M22x1,5
01001226	1/2"	13	-8	M26x1,6	18	32	DKL DN12 M26x1,5
01001626	5/8"	16	-10	M26x1,5	18	32	DKL DN16 M26x1,5
01001627	5/8"	16	-10	M27x1,5	18	32	DKL DN16 M27x1,5
010016272	5/8"	16	-10	M27x2	18	32	DKL DN16 M27x2
01002030	3/4"	19	-12	M30x1,5	22	36	DKL DN20 M30x1,5
010020302	3/4"	19	-12	M30x2	22	36	DKL DN20 M30x2
01002033	3/4"	19	-12	M33x1,5	28	41	DKL DN20 M33x1,5
010020332	3/4"	19	-12	M33x2	22	41	DKL DN20 M33x2
01002536	1"	25	-16	M36x2	28	41	DKL DN25 M36x2
01002539	1"	25	-16	M39x1,5	28	46	DKL DN25 M39x1,5
01003245	1 1/4"	32	-20	M45x2	35	50	DKL DN32 M45x2
01004052	1 1/2"	38	-24	M52x2	42	60	DKL DN40 M52x2

DKL
0100

Koncovky_fittings

Hadice_hoses

Ochran_y_protections

AGM priame, metrický závit vonkajší 60° kužel'
AGM straight, male metric 60° cone seat

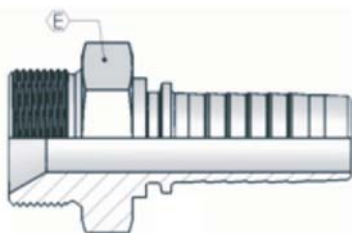
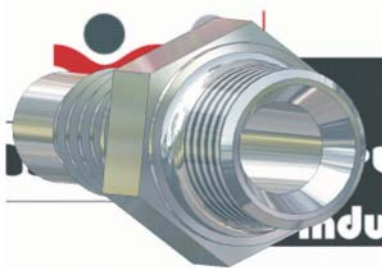

0143 AGM	Hadica / Hose			Závit	TR DIN	Kľúč E	Označenie
Kód/Code	inch	DN	Size	Thread	DIN PIPE	Hex E	Description
01430610	1/4"	06	-4	M10x1		15	DKM 90 DN06 M10x1
01430612	1/4"	06	-4	M12x1,5		17	DKM 90 DN06 M12x1,5
01430614	1/4"	06	-4	M14x1,5		19	DKM 90 DN06 M14x1,5
01430616	1/4"	06	-4	M16x1,5		22	DKM 90 DN06 M16x1,5
01430618	1/4"	06	-4	M18x1,5		22	DKM 90 DN06 M18x1,5
01430814	5/16"	08	-5	M14x1,5		17	DKM 90 DN08 M14x1,5
01430816	5/16"	08	-5	M16x1,5		22	DKM 90 DN08 M16x1,5
01430818	5/16"	08	-5	M18x1,5		24	DKM 90 DN08 M18x1,5
01431014	3/8"	10	-6	M14x1,5		19	DKM 90 DN10 M14x1,5
01431016	3/8"	10	-6	M16x1,5		22	DKM 90 DN10 M16x1,5
01431018	3/8"	10	-6	M18x1,5		24	DKM 90 DN10 M18x1,5
01431020	3/8"	10	-6	M20x1,5		27	DKM 90 DN10 M20x1,5
01431022	3/8"	10	-6	M22x1,5		27	DKM 90 DN10 M22x1,5
01431218	1/2"	12	-8	M18x1,5		24	DKM 90 DN12 M18x1,5
01431220	1/2"	12	-8	M20x1,5		27	DKM 90 DN12 M20x1,5
01431222	1/2"	12	-8	M22x1,5		27	DKM 90 DN12 M22x1,5
01431224	1/2"	12	-8	M24x1,5		30	DKM 90 DN12 M24x1,5
01431226	1/2"	12	-8	M26x1,5		32	DKM 90 DN12 M26x1,5
01431626	5/8"	16	-10	M26x1,5		32	DKM 90 DN16 M26x1,5
01432026	3/4"	20	-12	M26x1,5		32	DKM 90 DN20 M26x1,5
01432030	3/4"	20	-12	M30x1,5		36	DKM 90 DN20 M30x1,5
01432538	1"	25	-16	M38x1,5		46	DKM 90 DN25 M38x1,5
01433245	1 1/4"	32	-20	M45x1,5		55	DKM 90 DN32 M45x1,5

AGM
0143

Note:



DKM priame, metrický závit vonkajší 60° kužeľ
DKM straight, male metric 60° cone seat

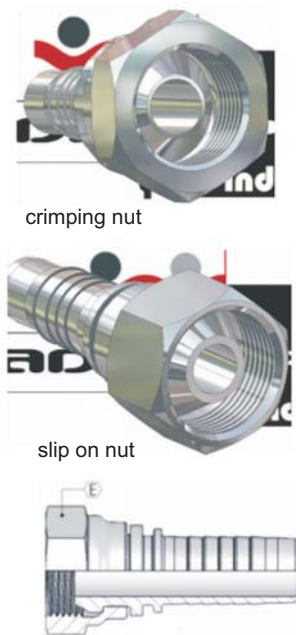

0140 DKM	Hadica / Hose			Závit	TR DIN	Klíč E	Označenie
Kód/Code	inch	DN	Size	Thread	DIN PIPE	Hex E	Description
01400610	1/4	06	-4	M10x1		15	DKM DN06 M10x1
01400612	1/4	06	-4	M12x1,5		17	DKM DN06 M12x1,5
01400614	1/4	06	-4	M14x1,5		17	DKM DN06 M14x1,5
01400616	1/4	06	-4	M16x1,5		22	DKM DN06 M16x1,5
01400618	1/4	06	-4	M18x1,5		22	DKM DN06 M18x1,5
01400814	5/16	08	-5	M14x1,5		17	DKM DN08 M14x1,5
01400816	5/16	08	-5	M16x1,5		22	DKM DN08 M16x1,5
01400818	5/16	08	-5	M18x1,5		22	DKM DN08 M18x1,5
01401014	3/8	10	-6	M14x1,5		17	DKM DN10 M14x1,5
01401016	3/8	10	-6	M16x1,5		22	DKM DN10 M16x1,5
01401018	3/8	10	-6	M18x1,5		22	DKM DN10 M18x1,5
01401020	3/8	10	-6	M20x1,5		27	DKM DN10 M20x1,5
01401022	3/8	10	-6	M22x1,5		27	DKM DN10 M22x1,5
01401218	1/2	12	-8	M18x1,5		22	DKM DN12 M18x1,5
01401220	1/2	12	-8	M20x1,5		27	DKM DN12 M20x1,5
01401222	1/2	12	-8	M22x1,5		27	DKM DN12 M22x1,5
01401224	1/2	12	-8	M24x1,5		30	DKM DN12 M24x1,5
01401226	1/2	12	-8	M26x1,5		32	DKM DN12 M26x1,5
01401626	5/8	16	-10	M26x1,5		32	DKM DN16 M26x1,5
01402026	3/4	20	-12	M26x1,5		32	DKM DN20 M26x1,5
01402030	3/4	20	-12	M30x1,5		36	DKM DN20 M30x1,5
01402538	1	25	-16	M38x1,5		46	DKM DN25 M38x1,5
01403245	1 1/4	32	-20	M45x1,5		50	DKM DN32 M45x1,5

crimping or slip on nut / zalisovaná alebo voľná matica

Koncovky_fittings

Hadice_hoses

Ochrany_protections

DKM
0140

DKM 45° koleno, metrický závit vnútorný 60° kužeľ
DKM 45° elbow, female metric 60° cone seat



0144 DKM 45	Hadica / Hose			Závit	TR DIN	Klíč E	Označenie
Kód/Code	inch	DN	Size	Thread	DIN PIPE	Hex E	Description
01440610	1/4	06	-4	M10x1		15	DKM 45 DN06 M10x1
01440612	1/4	06	-4	M12x1,5		17	DKM 45 DN06 M12x1,5
01440614	1/4	06	-4	M14x1,5		17	DKM 45 DN06 M14x1,5
01440616	1/4	06	-4	M16x1,5		22	DKM 45 DN06 M16x1,5
01440618	1/4	06	-4	M18x1,5		22	DKM 45 DN06 M18x1,5
01440814	5/16	08	-5	M14x1,5		17	DKM 45 DN08 M14x1,5
01440816	5/16	08	-5	M16x1,5		22	DKM 45 DN08 M16x1,5
01440818	5/16	08	-5	M18x1,5		22	DKM 45 DN08 M18x1,5
01441014	3/8	10	-6	M14x1,5		17	DKM 45 DN10 M14x1,5
01441016	3/8	10	-6	M16x1,5		22	DKM 45 DN10 M16x1,5
01441018	3/8	10	-6	M18x1,5		22	DKM 45 DN10 M18x1,5
01441020	3/8	10	-6	M20x1,5		27	DKM 45 DN10 M20x1,5
01441022	3/8	10	-6	M22x1,5		27	DKM 45 DN10 M22x1,5
01441218	1/2	12	-8	M18x1,5		22	DKM 45 DN12 M18x1,5
01441220	1/2	12	-8	M20x1,5		27	DKM 45 DN12 M20x1,5
01441222	1/2	12	-8	M22x1,5		27	DKM 45 DN12 M22x1,5
01441224	1/2	12	-8	M24x1,5		30	DKM 45 DN12 M24x1,5
01441226	1/2	12	-8	M26x1,5		32	DKM 45 DN12 M26x1,5
01441626	5/8	16	-10	M26x1,5		32	DKM 45 DN16 M26x1,5
01442026	3/4	20	-12	M26x1,5		32	DKM 45 DN20 M26x1,5
01442030	3/4	20	-12	M30x1,5		36	DKM 45 DN20 M30x1,5
01442538	1	25	-16	M38x1,5		46	DKM 45 DN25 M38x1,5
01443245	1 1/4	32	-20	M45x1,5		50	DKM 45 DN32 M45x1,5

crimping or slip on nut / zalisovaná alebo voľná matica

Note:

DKM 45
0144



DKM 90° koleno, metrický závit vnútorný 60° kužel
DKM 90° elbow, female metric 60° cone seat



0149 DKM 90	Hadica / Hose			Závit	TR DIN	Klíúč E	Označenie
Kód/Code	inch	DN	Size	Thread	DIN PIPE	Hex E	Description
01490610	1/4	06	-4	M10x1,5		15	DKM 90 DN06 M10x1,5
01490612	1/4	06	-4	M12x1,5		17	DKM 90 DN06 M12x1,5
01490614	1/4	06	-4	M14x1,5		17	DKM 90 DN06 M14x1,5
01490616	1/4	06	-4	M16x1,5		22	DKM 90 DN06 M16x1,5
01490618	1/4	06	-4	M18x1,5		22	DKM 90 DN06 M18x1,5
01490814	5/16	08	-5	M14x1,5		17	DKM 90 DN08 M14x1,5
01490816	5/16	08	-5	M16x1,5		22	DKM 90 DN08 M16x1,5
01490818	5/16	08	-5	M18x1,5		22	DKM 90 DN08 M18x1,5
01491014	3/8	10	-6	M14x1,5		17	DKM 90 DN10 M14x1,5
01491016	3/8	10	-6	M16x1,5		22	DKM 90 DN10 M16x1,5
01491018	3/8	10	-6	M18x1,5		22	DKM 90 DN10 M18x1,5
01491020	3/8	10	-6	M20x1,5		27	DKM 90 DN10 M20x1,5
01491022	3/8	10	-6	M22x1,5		27	DKM 90 DN10 M22x1,5
01491218	1/2	12	-8	M18x1,5		22	DKM 90 DN12 M18x1,5
01491220	1/2	12	-8	M20x1,5		27	DKM 90 DN12 M20x1,5
01491222	1/2	12	-8	M22x1,5		27	DKM 90 DN12 M22x1,5
01491224	1/2	12	-8	M24x1,5		30	DKM 90 DN12 M24x1,5
01491226	1/2	12	-8	M26x1,5		32	DKM 90 DN12 M26x1,5
01491626	5/8	16	-10	M26x1,5		32	DKM 90 DN16 M26x1,5
01492026	3/4	20	-12	M26x1,5		32	DKM 90 DN20 M26x1,5
01492030	3/4	20	-12	M30x1,5		36	DKM 90 DN20 M30x1,5
01492538	1	25	-16	M38x1,5		46	DKM 90 DN25 M38x1,5
01493245	1 1/4	32	-20	M45x1,5		50	DKM 90 DN32 M45x1,5

crimping or slip on nut / zalisovaná alebo voľná matica

Koncovky fittings

Hadice hoses

Ochrany protections

DKM 90
0149

BEL BES priame, metrická trubka L.T. (BEL) a H.T. (BES)
BEL BES straight, metric standpipe L.T. (BEL) and H.T.(BES)

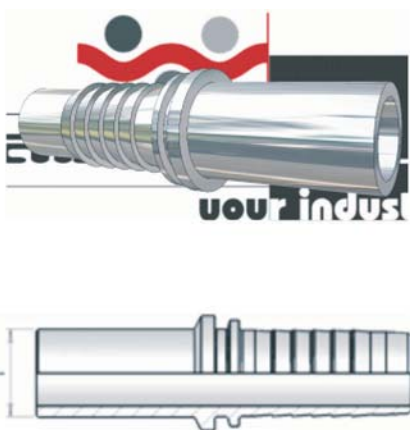

0130 BEL/S	Hadica / Hose			Trubka T		Označenie
Kód/Code	inch	DN	Size	Tube T		Description
01300506	3/16	05	-3	6		BEL DN05 T6
01300508	3/16	05	-3	8		BES DN05 T8
01300606	1/4	06	-4	6		BEL DN06 T6
01300608	1/4	06	-4	8		BES DN06 T8
01300610	1/4	06	-4	10		BES DN06 T10
01300612	1/4	06	-4	12		BES DN06 T12
01300808	5/16	08	-5	08		BES DN08 T8
01300810	5/16	08	-5	10		BEL DN08 T10
01300812	5/16	08	-5	12		BES DN08 T12
01301010	3/8	10	-6	10		BEL DN10 T10
01301012	3/8	10	-6	12		BEL DN10 T12
01301014	3/8	10	-6	14		BES DN10 T14
01301015	3/8	10	-6	15		BEL DN10 T15
01301212	1/2	12	-8	12		BEL DN12 T12
01301214	1/2	12	-8	14		BES DN12 T14
01301215	1/2	12	-8	15		BEL DN12 T15
01301216	1/2	12	-8	16		BES DN12 T16
01301218	1/2	12	-8	18		BEL DN12 T18
01301220	1/2	12	-8	20		BES DN12 T20
01301618	5/8	16	-10	18		BEL DN16 T18
01301620	5/8	16	-10	20		BES DN16 T20
01301622	5/8	16	-10	22		BEL DN16 T22
01302018	3/4	20	-12	18		BEL DN20 T18
01302020	3/4	20	-12	20		BES DN20 T20
01302022	3/4	20	-12	22		BEL DN20 T22
01302025	3/4	20	-12	25		BES DN20 T25
01302525	1	25	-16	25		BES DN25 T25
01302528	1	25	-16	28		BEL DN25 T28
01302530	1	25	-16	30		BES DN25 T30
01302535	1	25	-16	35		BEL DN25 T35
01303230	1 1/4	32	-20	30		BES DN32 T30
01303235	1 1/4	32	-20	35		BEL DN32 T35
01303238	1 1/4	32	-20	38		BES DN32 T38
01304038	1 1/2	40	-24	38		BES DN40 T38
01304042	1 1/2	40	-24	42		BEL DN40 T42

BEL BES
0130

Note:



BEL BES 45° koleno, metrická trubka L.T. (BEL) a H.T. (BES)
BEL BES 45° elbow, metric standpipe L.T. (BEL) and H.T. (BES)



0134 BEL/S45	Hadica / Hose			Trubka T		Označenie
Kód/Code	inch	DN	Size	Tube T		Description
01340506	3/16	05	-3	6		BEL 45 DN05 T6
01340508	3/16	05	-3	8		BES 45 DN05 T8
01340606	1/4	06	-4	6		BEL 45 DN06 T6
01340608	1/4	06	-4	8		BES 45 DN06 T8
01340610	1/4	06	-4	10		BES 45 DN06 T10
01340612	1/4	06	-4	12		BES 45 DN06 T12
01340808	5/16	08	-5	08		BES 45 DN08 T8
01340810	5/16	08	-5	10		BEL 45 DN08 T10
01340812	5/16	08	-5	12		BES 45 DN08 T12
01341010	3/8	10	-6	10		BEL 45 DN10 T10
01341012	3/8	10	-6	12		BEL 45 DN10 T12
01341014	3/8	10	-6	14		BES 45 DN10 T14
01341015	3/8	10	-6	15		BEL 45 DN10 T15
01341212	1/2	12	-8	12		BEL 45 DN12 T12
01341214	1/2	12	-8	14		BES 45 DN12 T14
01341215	1/2	12	-8	15		BEL 45 DN12 T15
01341216	1/2	12	-8	16		BES 45 DN12 T16
01341218	1/2	12	-8	18		BEL 45 DN12 T18
01341220	1/2	12	-8	20		BES 45 DN12 T20
01341618	5/8	16	-10	18		BEL 45 DN16 T18
01341620	5/8	16	-10	20		BES 45 DN16 T20
01341622	5/8	16	-10	22		BEL 45 DN16 T22
01342018	3/4	20	-12	18		BEL 45 DN20 T18
01342020	3/4	20	-12	20		BES 45 DN20 T20
01342022	3/4	20	-12	22		BEL 45 DN20 T22
01342025	3/4	20	-12	25		BES 45 DN20 T25
01342525	1	25	-16	25		BES 45 DN25 T25
01342528	1	25	-16	28		BEL 45 DN25 T28
01342530	1	25	-16	30		BES 45 DN25 T30
01342535	1	25	-16	35		BEL 45 DN25 T35
01343230	1 1/4	32	-20	30		BES 45 DN32 T30
01343235	1 1/4	32	-20	35		BEL 45 DN32 T35
01343238	1 1/4	32	-20	38		BES 45 DN32 T38
01344038	1 1/2	40	-24	38		BES 45 DN40 T38
01344042	1 1/2	40	-24	42		BEL 45 DN40 T42

Koncovky_fittings Hadice_hoses Ochrany_protections

BEL BES 0134 45

BEL BES 90° koleno, metrická trubka L.T. (BEL) a H.T. (BES)
BEL BES 90° elbow, metric standpipe L.T. (BEL) and H.T.(BES)



0139 BEL/S90	Hadica / Hose			Trubka T		Označenie
Kód/Code	inch	DN	Size	Tube T		Description
01390506	3/16	05	-3	6		BEL 90 DN05 T6
01390508	3/16	05	-3	8		BES 90 DN05 T8
01390606	1/4	06	-4	6		BEL 90 DN06 T6
01390608	1/4	06	-4	8		BES 90 DN06 T8
01390610	1/4	06	-4	10		BES 90 DN06 T10
01390612	1/4	06	-4	12		BES 90 DN06 T12
01390808	5/16	08	-5	08		BES 90 DN08 T8
01390810	5/16	08	-5	10		BEL 90 DN08 T10
01390812	5/16	08	-5	12		BES 90 DN08 T12
01391010	3/8	10	-6	10		BEL 90 DN10 T10
01391012	3/8	10	-6	12		BEL 90 DN10 T12
01391014	3/8	10	-6	14		BES 90 DN10 T14
01391015	3/8	10	-6	15		BEL 90 DN10 T15
01391212	1/2	12	-8	12		BEL 90 DN12 T12
01391214	1/2	12	-8	14		BES 90 DN12 T14
01391215	1/2	12	-8	15		BEL 90 DN12 T15
01391216	1/2	12	-8	16		BES 90 DN12 T16
01391218	1/2	12	-8	18		BEL 90 DN12 T18
01391220	1/2	12	-8	20		BES 90 DN12 T20
01391618	5/8	16	-10	18		BEL 90 DN16 T18
01391620	5/8	16	-10	20		BES 90 DN16 T20
01391622	5/8	16	-10	22		BEL 90 DN16 T22
01392018	3/4	20	-12	18		BEL 90 DN20 T18
01392020	3/4	20	-12	20		BES 90 DN20 T20
01392022	3/4	20	-12	22		BEL 90 DN20 T22
01392025	3/4	20	-12	25		BES 90 DN20 T25
01392525	1	25	-16	25		BES 90 DN25 T25
01392528	1	25	-16	28		BEL 90 DN25 T28
01392530	1	25	-16	30		BES 90 DN25 T30
01392535	1	25	-16	35		BEL 90 DN25 T35
01393230	1 1/4	32	-20	30		BES 90 DN32 T30
01393235	1 1/4	32	-20	35		BEL 90 DN32 T35
01393238	1 1/4	32	-20	38		BES 90 DN32 T38
01394038	1 1/2	40	-24	38		BES 90 DN40 T38
01394042	1 1/2	40	-24	42		BEL 90 DN40 T42

BEL BES 0139 90



let's work us

AGR, priama, BSP (BSPP) závit vonkajší 60° kužel, BS 5200
AGR, straight, BSP (BSPP) male 60° cone seat, BS 5200

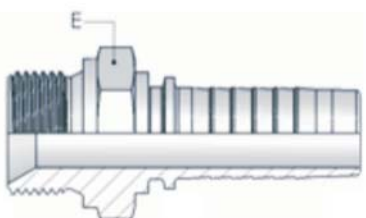

0203 AGR	Hadica / Hose			Závit	TR DIN	Klíč E	Označenie
Kód/Code	inch	DN	Size	Thread	DIN PIPE	Hex E	Description
02030505	3/16	05	-3	G 1/8"		14	AGR DN05 1/8
02030506	3/16	05	-3	G 1/4"		19	AGR DN05 1/4
02030605	1/4	06	-4	G 1/8"		14	AGR DN06 1/8
02030606	1/4	06	-4	G 1/4"		19	AGR DN06 1/4
02030610	1/4	06	-4	G 3/8"		22	AGR DN06 3/8
02030612	1/4	06	-4	G 1/2"		27	AGR DN06 1/2
02030806	5/16	08	-5	G 1/4"		19	AGR DN08 1/4
02030810	5/16	08	-5	G 3/8"		22	AGR DN08 3/8
02030812	5/16	08	-5	G 1/2"		27	AGR DN08 1/2
02031006	3/8	10	-6	G 1/4"		19	AGR DN10 1/4
02031010	3/8	10	-6	G 3/8"		22	AGR DN10 3/8
02031012	3/8	10	-6	G 1/2"		27	AGR DN10 1/2
02031210	1/2	12	-8	G 3/8"		22	AGR DN12 3/8
02031212	1/2	12	-8	G 1/2"		27	AGR DN12 1/2
02031216	1/2	12	-8	G 5/8"		28	AGR DN12 5/8
02031220	1/2	12	-8	G 3/4"		32	AGR DN12 3/4
02031612	5/8	16	-10	G 1/2"		27	AGR DN16 1/2
02031616	5/8	16	-10	G 5/8"		28	AGR DN16 5/8
02031620	5/8	16	-10	G 3/4"		32	AGR DN16 3/4
02031625	5/8	16	-10	G 1"		38	AGR DN16 1
02032020	3/4	20	-12	G 3/4"		32	AGR DN20 3/4
02032025	3/4	20	-12	G 1"		38	AGR DN20 1
02032525	1	25	-16	G 1"		38	AGR DN25 1
02032532	1	25	-16	G 1" 1/4		50	AGR DN25 1 1/4
02033232	1 1/4	32	-20	G 1" 1/4		50	AGR DN32 1 1/4
02033238	1 1/4	32	-20	G 1" 1/2		55	AGR DN32 1 1/2
02034040	1 1/2	40	-24	G 1" 1/2		55	AGR DN40 1 1/2
02034050	1 1/2	40	-24	G 2"		70	AGR DN40 2
02035050	2	50	-32	G 2"		70	AGR DN50 2

AGR
0203

Koncovky_fittings

Hadice_hoses

Ochrany_protections

AGR-K, priama, BSP (BSPT) kuželový závit vonkajší 60° kužel, BS 5200
AGR-K, straight, BSP (BSPT) tapered male 60° cone seat, BS 5200

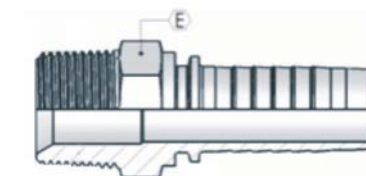

0205 AGR-K	Hadica / Hose			Závit	TR DIN	Klíč E	Označenie
Kód/Code	inch	DN	Size	Thread	DIN PIPE	Hex E	Description
02050505	3/16	05	-3	G 1/8"		12	AGR-K DN05 1/8
02050506	3/16	05	-3	G 1/4"		17	AGR-K DN05 1/4
02050605	1/4	06	-4	G 1/8"		12	AGR-K DN06 1/8
02050606	1/4	06	-4	G 1/4"		17	AGR-K DN06 1/4
02050610	1/4	06	-4	G 3/8"		19	AGR-K DN06 3/8
02050806	5/16	08	-5	G 1/4"		17	AGR-K DN08 1/4
02050810	5/16	08	-5	G 3/8"		19	AGR-K DN08 3/8
02050812	5/16	08	-5	G 1/2"		22	AGR-K DN08 1/2
02051006	3/8	10	-6	G 1/4"		17	AGR-K DN10 1/4
02051010	3/8	10	-6	G 3/8"		19	AGR-K DN10 3/8
02051012	3/8	10	-6	G 1/2"		22	AGR-K DN10 1/2
02051210	1/2	12	-8	G 3/8"		19	AGR-K DN12 3/8
02051212	1/2	12	-8	G 1/2"		22	AGR-K DN12 1/2
02051216	1/2	12	-8	G 5/8"		30	AGR-K DN12 5/8
02051220	1/2	12	-8	G 3/4"		30	AGR-K DN12 3/4
02051612	5/8	16	-10	G 1/2"		22	AGR-K DN16 1/2
02051616	5/8	16	-10	G 5/8"		30	AGR-K DN16 5/8
02051620	5/8	16	-10	G 3/4"		30	AGR-K DN16 3/4
02051625	5/8	16	-10	G 1"		36	AGR-K DN16 1
02052020	3/4	20	-12	G 3/4"		30	AGR-K DN20 3/4
02052025	3/4	20	-12	G 1"		36	AGR-K DN20 1
02052525	1	25	-16	G 1"		36	AGR-K DN25 1
02052532	1	25	-16	G 1" 1/4		46	AGR-K DN25 1 1/4
02053232	1 1/4	32	-20	G 1" 1/4		46	AGR-K DN32 1 1/4
02053238	1 1/4	32	-20	G 1" 1/2		50	AGR-K DN32 1 1/2
02054040	1 1/2	40	-24	G 1" 1/2		50	AGR-K DN40 1 1/2
02054050	1 1/2	40	-24	G 2"		65	AGR-K DN40 2
02055050	2	50	-32	G 2"		65	AGR-K DN50 2

AGR-K
0205



let's work us

AGN, priama, NPTF závit vonkajší 60° kužel'
AGN, straight, NPTF male 60° cone seat

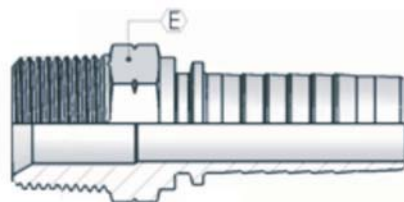
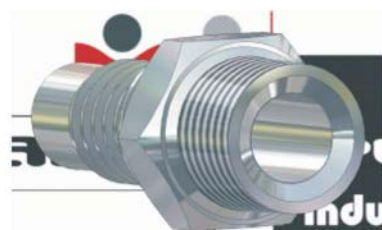

0207 AGN	Hadica / Hose			Závit	TR DIN	Klíč E	Označenie
Kód/Code	inch	DN	Size	Thread	DIN PIPE	Hex E	Description
02070505	3/16	05	-3	G 1/8"-27		12	AGN DN05 1/8-27
02070506	3/16	05	-3	G 1/4"-18		17	AGN DN05 1/4-18
02070605	1/4	06	-4	G 1/8"-27		12	AGN DN06 1/8-27
02070606	1/4	06	-4	G 1/4"-18		17	AGN DN06 1/4-18
02070610	1/4	06	-4	G 3/8"-18		19	AGN DN06 3/8-18
02070806	5/16	08	-5	G 1/4"-18		17	AGN DN08 1/4-18
02070810	5/16	08	-5	G 3/8"-18		19	AGN DN08 3/8-18
02070812	5/16	08	-5	G 1/2"-14		22	AGN DN08 1/2-14
02071006	3/8	10	-6	G 1/4"-18		17	AGN DN10 1/4-18
02071010	3/8	10	-6	G 3/8"-18		19	AGN DN10 3/8-18
02071012	3/8	10	-6	G 1/2"-14		22	AGN DN10 1/2-14
02071210	1/2	12	-8	G 3/8"-18		19	AGN DN12 3/8-18
02071212	1/2	12	-8	G 1/2"-14		22	AGN DN12 1/2-14
02071220	1/2	12	-8	G 3/4"-14		22	AGN DN12 3/4-14
02071612	5/8	16	-10	G 1/2"-14		22	AGN DN16 1/2-14
02071620	5/8	16	-10	G 3/4"-14		22	AGN DN16 3/4-14
02071625	5/8	16	-10	G 1"-11,5			AGN DN16 1-11,5
02072020	3/4	20	-12	G 3/4"-14		22	AGN DN20 3/4-14
02072025	3/4	20	-12	G 1"-11,5		36	AGN DN20 1-11,5
02072525	1	25	-16	G 1"-11,5		36	AGN DN25 1-11,5
02072532	1	25	-16	G 1" 1/4-11,5		46	AGN DN25 1 1/4-11,5
02073232	1 1/4	32	-20	G 1" 1/4-11,5		46	AGN DN32 1 1/4-11,5
02073238	1 1/4	32	-20	G 1" 1/2-11,5		50	AGN DN32 1 1/2-11,5
02074040	1 1/2	40	-24	G 1" 1/2-11,5		50	AGN DN40 1 1/2-11,5
02074050	1 1/2	40	-24	G 2"-11,5		65	AGN DN40 2-11,5
02075050	2	50	-32	G 2"-11,5		65	AGN DN50 2-11,5

AGN
0207

Koncovky_fittings

Hadice_hoses

Ochrany_protections

DKR, priama, BSP závit vnútorný 60° kužel', BS 5200
DKR, straight, BSP thread female 60° cone seat, BS 5200

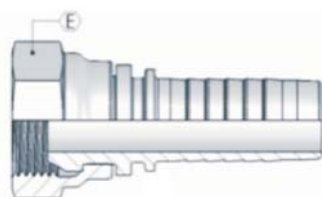
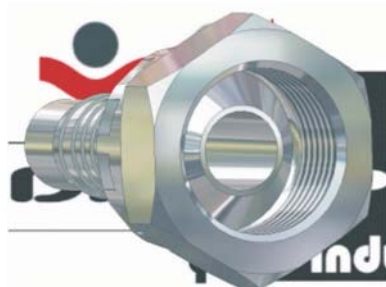

0200 DKR	Hadica / Hose			Závit	TR DIN	Klíč E	Označenie
Kód/Code	inch	DN	Size	Thread	DIN PIPE	Hex E	Description
02000505	3/16	05	-3	G 1/8"		14	DKR DN05 1/8
02000506	3/16	05	-3	G 1/4"		19	DKR DN05 1/4
02000605	1/4	06	-4	G 1/8"		14	DKR DN06 1/8
02000606	1/4	06	-4	G 1/4"		19	DKR DN06 1/4
02000610	1/4	06	-4	G 3/8"		22	DKR DN06 3/8
02000806	5/16	08	-5	G 1/4"		19	DKR DN08 1/4
02000810	5/16	08	-5	G 3/8"		22	DKR DN08 3/8
02000812	5/16	08	-5	G 1/2"		27	DKR DN08 1/2
02001006	3/8	10	-6	G 1/4"		19	DKR DN10 1/4
02001010	3/8	10	-6	G 3/8"		22	DKR DN10 3/8
02001012	3/8	10	-6	G 1/2"		27	DKR DN10 1/2
02001210	1/2	12	-8	G 3/8"		22	DKR DN12 3/8
02001212	1/2	12	-8	G 1/2"		27	DKR DN12 1/2
02001216	1/2	12	-8	G 5/8"		28	DKR DN12 5/8
02001220	1/2	12	-8	G 3/4"		32	DKR DN12 3/4
02001612	5/8	16	-10	G 1/2"		27	DKR DN16 1/2
02001616	5/8	16	-10	G 5/8"		28	DKR DN16 5/8
02001620	5/8	16	-10	G 3/4"		32	DKR DN16 3/4
02002020	3/4	20	-12	G 3/4"		32	DKR DN20 3/4
02002025	3/4	20	-12	G 1"		38	DKR DN20 1
02002525	1	25	-16	G 1"		38	DKR DN25 1
02002532	1	25	-16	G 1" 1/4		50	DKR DN25 1 1/4
02003232	1 1/4	32	-20	G 1" 1/4		50	DKR DN32 1 1/4
02003238	1 1/4	32	-20	G 1" 1/2		55	DKR DN32 1 1/2
02004040	1 1/2	40	-24	G 1" 1/2		55	DKR DN40 1 1/2
02004050	1 1/2	40	-24	G 2"		70	DKR DN40 2
02005050	2	50	-32	G 2"		70	DKR DN50 2

DKR
0200

Note:



DKR 45° koleno, BSP závit vnútorný 60° kužeľ, BS 5200
DKR 45° elbow, BSP thread female 60° cone seat, BS 5200



0204 DKR 45	Hadica / Hose			Závit	TR DIN	Klúč E	Označenie
Kód/Code	inch	DN	Size	Thread	DIN PIPE	Hex E	Description
02040505	3/16	05	-3	G 1/8"		14	DKR 45 DN05 1/8
02040506	3/16	05	-3	G 1/4"		19	DKR 45 DN05 1/4
02040605	1/4	06	-4	G 1/8"		14	DKR 45 DN06 1/8
02040606	1/4	06	-4	G 1/4"		19	DKR 45 DN06 1/4
02040610	1/4	06	-4	G 3/8"		22	DKR 45 DN06 3/8
02040806	5/16	08	-5	G 1/4"		19	DKR 45 DN08 1/4
02040810	5/16	08	-5	G 3/8"		22	DKR 45 DN08 3/8
02040812	5/16	08	-5	G 1/2"		27	DKR 45 DN08 1/2
02041006	3/8	10	-6	G 1/4"		19	DKR 45 DN10 1/4
02041010	3/8	10	-6	G 3/8"		22	DKR 45 DN10 3/8
02041012	3/8	10	-6	G 1/2"		27	DKR 45 DN10 1/2
02041210	1/2	12	-8	G 3/8"		22	DKR 45 DN12 3/8
02041212	1/2	12	-8	G 1/2"		27	DKR 45 DN12 1/2
02041216	1/2	12	-8	G 5/8"		28	DKR 45 DN12 5/8
02041220	1/2	12	-8	G 3/4"		32	DKR 45 DN12 3/4
02041612	5/8	16	-10	G 1/2"		27	DKR 45 DN16 1/2
02041616	5/8	16	-10	G 5/8"		28	DKR 45 DN16 5/8
02041620	5/8	16	-10	G 3/4"		32	DKR 45 DN16 3/4
02042020	3/4	20	-12	G 3/4"		32	DKR 45 DN20 3/4
02042025	3/4	20	-12	G 1"		38	DKR 45 DN20 1
02042525	1	25	-16	G 1"		38	DKR 45 DN25 1
02042532	1	25	-16	G 1" 1/4		50	DKR 45 DN25 1 1/4
02043232	1 1/4	32	-20	G 1" 1/4		50	DKR 45 DN32 1 1/4
02043238	1 1/4	32	-20	G 1" 1/2		55	DKR 45 DN32 1 1/2
02044040	1 1/2	40	-24	G 1" 1/2		55	DKR 45 DN40 1 1/2
02044050	1 1/2	40	-24	G 2"		70	DKR 45 DN40 2
02045050	2	50	-32	G 2"		70	DKR 45 DN50 2

**DKR 45
0204**

Koncovky_fittings

Hadice_hoses

Ochrany_protections

DKR 90° koleno, BSP závit vnútorný 60° kužeľ, BS 5200
DKR 90° elbow, BSP thread female 60° cone seat, BS 5200

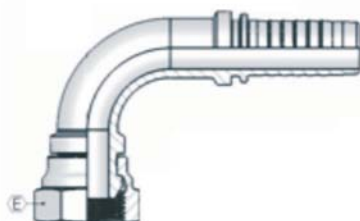

0209 DKR 90	Hadica / Hose			Závit	TR DIN	Klúč E	Označenie
Kód/Code	inch	DN	Size	Thread	DIN PIPE	Hex E	Description
02090505	3/16	05	-3	G 1/8"		14	DKR 90 DN05 1/8
02090506	3/16	05	-3	G 1/4"		19	DKR 90 DN05 1/4
02090605	1/4	06	-4	G 1/8"		14	DKR 90 DN06 1/8
02090606	1/4	06	-4	G 1/4"		19	DKR 90 DN06 1/4
02090610	1/4	06	-4	G 3/8"		22	DKR 90 DN06 3/8
02090806	5/16	08	-5	G 1/4"		19	DKR 90 DN08 1/4
02090810	5/16	08	-5	G 3/8"		22	DKR 90 DN08 3/8
02090812	5/16	08	-5	G 1/2"		27	DKR 90 DN08 1/2
02091006	3/8	10	-6	G 1/4"		19	DKR 90 DN10 1/4
02091010	3/8	10	-6	G 3/8"		22	DKR 90 DN10 3/8
02091012	3/8	10	-6	G 1/2"		27	DKR 90 DN10 1/2
02091210	1/2	12	-8	G 3/8"		22	DKR 90 DN12 3/8
02091212	1/2	12	-8	G 1/2"		27	DKR 90 DN12 1/2
02091216	1/2	12	-8	G 5/8"		28	DKR 90 DN12 5/8
02091220	1/2	12	-8	G 3/4"		32	DKR 90 DN12 3/4
02091612	5/8	16	-10	G 1/2"		27	DKR 90 DN16 1/2
02091616	5/8	16	-10	G 5/8"		28	DKR 90 DN16 5/8
02091620	5/8	16	-10	G 3/4"		32	DKR 90 DN16 3/4
02092020	3/4	20	-12	G 3/4"		32	DKR 90 DN20 3/4
02092025	3/4	20	-12	G 1"		38	DKR 90 DN20 1
02092525	1	25	-16	G 1"		38	DKR 90 DN25 1
02092532	1	25	-16	G 1" 1/4		50	DKR 90 DN25 1 1/4
02093232	1 1/4	32	-20	G 1" 1/4		50	DKR 90 DN32 1 1/4
02093238	1 1/4	32	-20	G 1" 1/2		55	DKR 90 DN32 1 1/2
02094040	1 1/2	40	-24	G 1" 1/2		55	DKR 90 DN40 1 1/2
02094050	1 1/2	40	-24	G 2"		70	DKR 90 DN40 2
02095050	2	50	-32	G 2"		70	DKR 90 DN50 2

**DKR 90
0209**



DKOR, priama, BSP závit vnútorný 60° kužel', s O-krúžkom BS 5200
DKOR, straight, BSP thread female 60° cone seat, with O-ring BS 5200

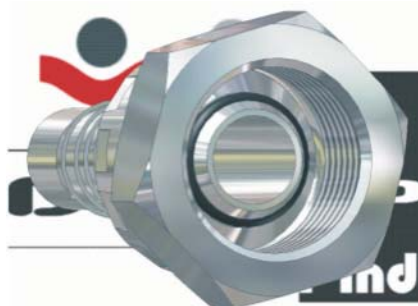

0210 DKOR	Hadica / Hose			Závit	TR DIN	Klíč E	Označenie
Kód/Code	inch	DN	Size	Thread	DIN PIPE	Hex E	Description
02100606	1/4"	6	-4	1/4"		19	DKOR DN06 1/4
02101010	3/8"	10	-6	3/8"		22	DKOR DN10 3/8
02101212	1/2"	13	-8	1/2"		27	DKOR DN12 1/2
02102020	3/4"	20	-12	3/4"		32	DKOR DN20 3/4
02102025	3/4"	20	-12	1"		38	DKOR DN20 1
02102525	1"	25	-16	1"		38	DKOR DN25 1
02102532	1"	25	-16	1 1/4"		50	DKOR DN25 1 1/4
02103232	1 1/4"	32	-20	1 1/4"		50	DKOR DN32 1 1/4
02103240	1 1/4"	32	-20	1 1/2"		55	DKOR DN32 1 1/2
02104040	1 1/2"	40	-24	1 1/2"		55	DKOR DN40 1 1/2
02104050	1 1/2"	40	-24	2"		70	DKOR DN40 2
02105050	2"	50	-32	2"		70	DKOR DN50 2

crimped or slip on nut / zalisovaná alebo voľná matica

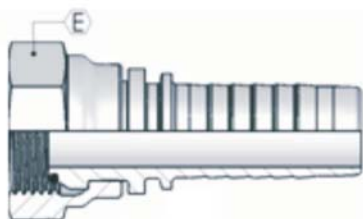

**DKOR
0210**

Koncovky_fittings

Hadice_hoses

Ochrany_protections

DKOR 45° koleno, BSP závit vnútorný 60° kužel', s O-krúžkom BS 5200
DKOR 45° elbow, BSP thread female 60° cone seat, with O-ring BS 5200



0214 DKOR 45	Hadica / Hose			Závit	TR DIN	Klíč E	Označenie
Kód/Code	inch	DN	Size	Thread	DIN PIPE	Hex E	Description
02140606	1/4"	6	-4	1/4"		19	DKOR 45 DN06 1/4
02141010	3/8"	10	-6	3/8"		22	DKOR 45 DN10 3/8
02141212	1/2"	13	-8	1/2"		27	DKOR 45 DN12 1/2
02142020	3/4"	20	-12	3/4"		32	DKOR 45 DN20 3/4
02142025	3/4"	20	-12	1"		38	DKOR 45 DN20 1
02142525	1"	25	-16	1"		38	DKOR 45 DN25 1
02142532	1"	25	-16	1 1/4"		50	DKOR 45 DN25 1 1/4
02143232	1 1/4"	32	-20	1 1/4"		50	DKOR 45 DN32 1 1/4
02143240	1 1/4"	32	-20	1 1/2"		55	DKOR 45 DN32 1 1/2
02144040	1 1/2"	40	-24	1 1/2"		55	DKOR 45 DN40 1 1/2
02144050	1 1/2"	40	-24	2"		70	DKOR 45 DN40 2
02145050	2"	50	-32	2"		70	DKOR 45 DN50 2

crimped or slip on nut / zalisovaná alebo voľná matica

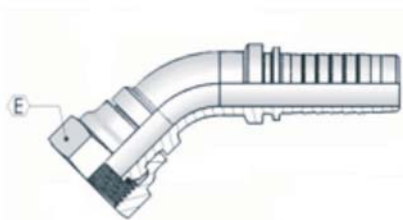

**DKOR 45
0214**

Note:



DKOR 90° koleno, BSP závit vnútorný 60° kužeľ, s O-kružkom BS 5200
DKOR 90° elbow, BSP thread female 60° cone seat, with O-ring BS 5200



0219 DKOR 90 Kód/Code	Hadica / Hose			Závit Thread	TR DIN DIN PIPE	Klíúč E Hex E	Označenie Description
	inch	DN	Size				
02190606	1/4"	6	-4	1/4"		19	DKOR 90 DN06 1/4
02191010	3/8"	10	-6	3/8"		22	DKOR 90 DN10 3/8
02191212	1/2"	13	-8	1/2"		27	DKOR 90 DN12 1/2
02192020	3/4"	20	-12	3/4"		32	DKOR 90 DN20 3/4
02192025	3/4"	20	-12	1"		38	DKOR 90 DN20 1
02192525	1"	25	-16	1"		38	DKOR 90 DN25 1
02192532	1"	25	-16	1 1/4"		50	DKOR 90 DN25 1 1/4
02193232	1 1/4"	32	-20	1 1/4"		50	DKOR 90 DN32 1 1/4
02193240	1 1/4"	32	-20	1 1/2"		55	DKOR 90 DN32 1 1/2
02194040	1 1/2"	40	-24	1 1/2"		55	DKOR 90 DN40 1 1/2
02194050	1 1/2"	40	-24	2"		70	DKOR 90 DN40 2
02195050	2"	50	-32	2"		70	DKOR 90 DN50 2

crimped or slip on nut / zalisovaná alebo voľná matica

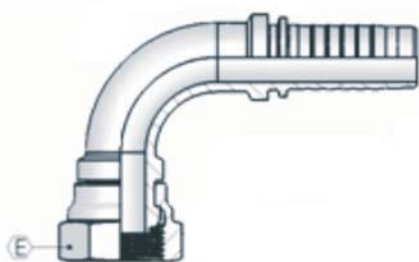

**DKOR 90
0219**

Koncovky_fittings

Hadice_hoses

Ochrany_protections

AGR FF, BSP závit vonkajší, rovné čelo, BS 5200
AGR FF, BSP thread male, flat face, BS 5200



0221 AGR FF Kód/Code	Hadica / Hose			Závit Thread	TR DIN DIN PIPE	Klíúč E Hex E	Označenie Description
	inch	DN	Size				
02210606	1/4"	06	-4	1/4"		19	AGR FF DN06 1/4
02211010	3/8"	10	-6	3/8"		22	AGR FF DN10 3/8
02211012	3/8"	10	-6	1/2"		27	AGR FF DN10 1/2
02211212	1/2"	12	-8	1/2"		27	AGR FF DN12 1/2
02211220	1/2"	12	-8	3/4"		32	AGR FF DN12 3/4
02211620	5/8"	16	-10	3/4"		32	AGR FF DN16 3/4
02212020	3/4"	20	-12	3/4"		32	AGR FF DN20 3/4
02212525	1"	25	-16	1"		38	AGR FF DN25 1

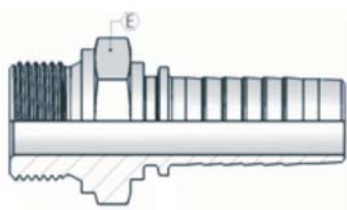

**AGR FF
0221**

Note:



DKR FF, BSP závit vnútorný, rovné čelo, BS 5200 DKR FF, BSP thread female, flat face, BS 5200

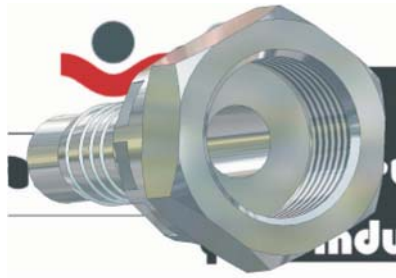

0220 DKR FF	Hadica / Hose			Závit	TR DIN	Klíúč E	Označenie
Kód/Code	inch	DN	Size	Thread	DIN PIPE	Hex E	Description
02200606	1/4	06	-4	1/4"		19	DKR FF DN06 1/4
02201010	3/8	10	-6	3/8"		22	DKR FF DN10 3/8
02201012	3/8	10	-6	1/2"		27	DKR FF DN10 1/2
02201212	1/2	12	-8	1/2"		27	DKR FF DN12 1/2
02201220	1/2	12	-8	3/4"		32	DKR FF DN12 3/4
02201620	5/8	16	-10	3/4"		32	DKR FF DN16 3/4
02202020	3/4	20	-12	3/4"		32	DKR FF DN20 3/4
02202525	1	25	-16	1"		38	DKR FF DN25 1

45° and 90° elbow on the request / 45° a 90° koleno na požiadanie
crimped, thrust wire nut or slip on nut / zalisovaná, zaistená matica alebo voľná matica

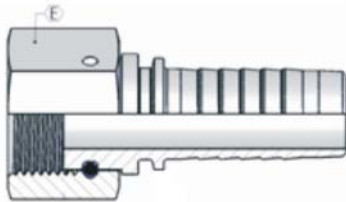

DKR FF
0220

Koncovky_fittings

Hadice_hoses

Ochrany_protections

DKR CP, BSP COMPACT závit vnútorný 60° kužel, s O-krúžkom BS 5200 DKR CP, BSP COMPACT thread female 60° cone seat, with O-ring BS 5200

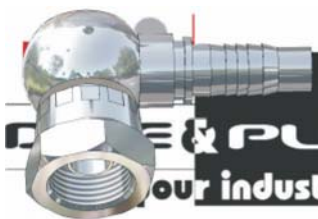

0225 DKR CP	Hadica / Hose			Závit	TR DIN	Klíúč E	Označenie
Kód/Code	inch	DN	Size	Thread	DIN PIPE	Hex E	Description
02250606	1/4	06	-4	1/4"		19	DKR CP DN06 1/4
02251010	3/8	10	-6	3/8"		22	DKR CP DN10 3/8
02251212	1/2	12	-8	1/2"		27	DKR CP DN12 1/2
02251620	5/8	16	-10	5/8"		32	DKR CP DN16 3/4
02252020	3/4	20	-12	3/4"		32	DKR CP DN20 3/4
02252525	1	25	-16	1"		38	DKR CP DN25 1

crimped, thrust wire nut / zalisovaná, zaistená matica.
Please mark type "G" or "R" by ordering / prosíme označte pri objednávaní typ "G" alebo "R".

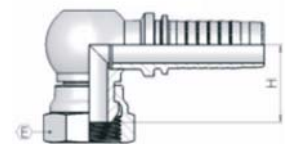

Type G

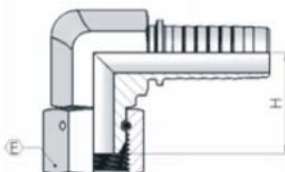

Type R

Note:

DKR CP
0225



AGF priame, Francúzsky metrický závit vonkajší 24° kužel, milimetrový typ
 AGF straight, French male metric 24° cone seat, millimetric type

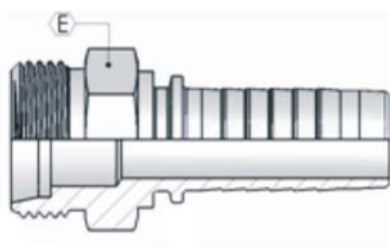
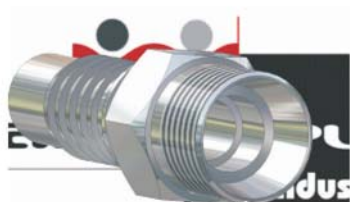

0153 AGF Kód/Code	Hadica / Hose		Závit Thread	TR DIN DIN PIPE	Klíúč E Hex E	Označenie Description
	inch	DN				
01530620	1/4	06	-4	M20x1,5	22	AGF DN06 M20x1,5
01530820	5/16	08	-5	M20x1,5	22	AGF DN08 M20x1,5
01531020	3/8	10	-6	M20x1,5	22	AGF DN10 M20x1,5
01531024	3/8	10	-6	M24x1,5	27	AGF DN10 M24x1,5
01531224	1/2	12	-8	M24x1,5	27	AGF DN12 M24x1,5
01531230	1/2	12	-8	M30x1,5	32	AGF DN12 M30x1,5
01531630	5/8	16	-10	M30x1,5	32	AGF DN16 M30x1,5
01532030	3/4	20	-12	M30x1,5	32	AGF DN20 M30x1,5
01532036	3/4	20	-12	M36x1,5	36	AGF DN20 M36x1,5
01532545	1	25	-16	M45x1,5	46	AGF DN25 M45x1,5
01533245	1 1/4	32	-20	M45x1,5	46	AGF DN32 M45x1,5

AGF
0153

Koncovky_fittings

Hadice_hoses

Ochrany_protections

DKF priame, Francúzsky metrický závit vnútorný 24° kužel, milimetrový typ
 DKF straight, French female metric 24° cone seat, millimetric type

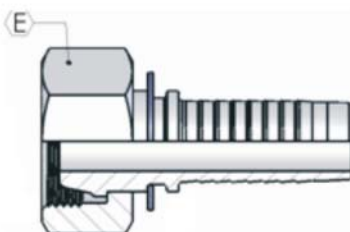
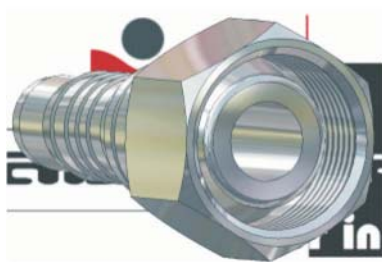

0150 DKF Kód/Code	Hadica / Hose		Závit Thread	TR DIN DIN PIPE	Klíúč E Hex E	Označenie Description
	inch	DN				
01500620	1/4	06	-4	M20x1,5	24	DKF DN06 M20x1,5
01500820	5/16	08	-5	M20x1,5	24	DKF DN08 M20x1,5
01501020	3/8	10	-6	M20x1,5	24	DKF DN10 M20x1,5
01501024	3/8	10	-6	M24x1,5	30	DKF DN10 M24x1,5
01501224	1/2	12	-8	M24x1,5	30	DKF DN12 M24x1,5
01501230	1/2	12	-8	M30x1,5	36	DKF DN12 M30x1,5
01501630	5/8	16	-10	M30x1,5	36	DKF DN16 M30x1,5
01502030	3/4	20	-12	M30x1,5	36	DKF DN20 M30x1,5
01502036	3/4	20	-12	M36x1,5	41	DKF DN20 M36x1,5
01502545	1	25	-16	M45x1,5	50	DKF DN25 M45x1,5
01503245	1 1/4	32	-20	M45x1,5	50	DKF DN32 M45x1,5

DKF
0150

Note:



DKF 45° koleno, Francúzsky metrický závit vonkajší 24° kužel', milimetrový typ
 DKF 45° elbow, French male metric 24° cone seat, millimetric type



0154 DKF 45	Hadica / Hose			Závit	TR DIN	Klíúč E	Označenie
Kód/Code	inch	DN	Size	Thread	DIN PIPE	Hex E	Description
01540620	1/4	06	-4	M20x1,5		24	DKF 45 DN06 M20x1,5
01540820	5/16	08	-5	M20x1,5		24	DKF 45 DN08 M20x1,5
01541020	3/8	10	-6	M20x1,5		24	DKF 45 DN10 M20x1,5
01541024	3/8	10	-6	M24x1,5		30	DKF 45 DN10 M24x1,5
01541224	1/2	12	-8	M24x1,5		30	DKF 45 DN12 M24x1,5
01541230	1/2	12	-8	M30x1,5		36	DKF 45 DN12 M30x1,5
01541630	5/8	16	-10	M30x1,5		36	DKF 45 DN16 M30x1,5
01542030	3/4	20	-12	M30x1,5		36	DKF 45 DN20 M30x1,5
01542036	3/4	20	-12	M36x1,5		41	DKF 45 DN20 M36x1,5
01542545	1	25	-16	M45x1,5		50	DKF 45 DN25 M45x1,5
01543245	1 1/4	32	-20	M45x1,5		50	DKF 45 DN32 M45x1,5

DKF 45
0154



Koncovky_fittings

Hadice_hoses

Ochrany_protections

DKF 90° koleno, Francúzsky metrický závit vnútorný 24° kužel', milimetrový typ
 DKF 90° elbow, French female metric 24° cone seat, millimetric type



0159 DKF 90	Hadica / Hose			Závit	TR DIN	Klíúč E	Označenie
Kód/Code	inch	DN	Size	Thread	DIN PIPE	Hex E	Description
01590620	1/4	06	-4	M20x1,5		24	DKF 90 DN06 M20x1,5
01590820	5/16	08	-5	M20x1,5		24	DKF 90 DN08 M20x1,5
01591020	3/8	10	-6	M20x1,5		24	DKF 90 DN10 M20x1,5
01591024	3/8	10	-6	M24x1,5		30	DKF 90 DN10 M24x1,5
01591224	1/2	12	-8	M24x1,5		30	DKF 90 DN12 M24x1,5
01591230	1/2	12	-8	M30x1,5		36	DKF 90 DN12 M30x1,5
01591630	5/8	16	-10	M30x1,5		36	DKF 90 DN16 M30x1,5
01592030	3/4	20	-12	M30x1,5		36	DKF 90 DN20 M30x1,5
01592036	3/4	20	-12	M36x1,5		41	DKF 90 DN20 M36x1,5
01592545	1	25	-16	M45x1,5		50	DKF 90 DN25 M45x1,5
01593245	1 1/4	32	-20	M45x1,5		50	DKF 90 DN32 M45x1,5

DKF 90
0159

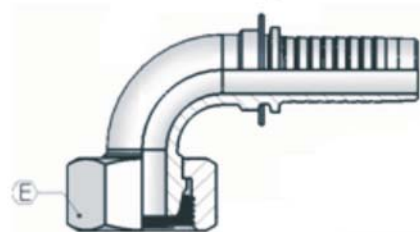

Note:



let's work us

AGJ priame, JIC závit vonkajší 74° kužel, SAE J516/J514
AGJ straight, JIC male thread 74° cone seat, SAE J516/J514

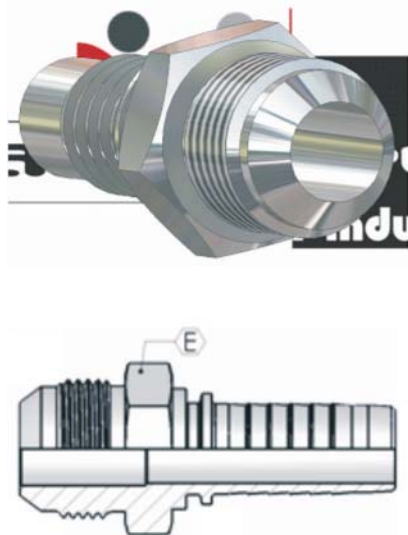

0303 AGJ	Hadica / Hose			Závit	TR DIN	Označenie
Kód/Code	inch	DN	Size	Thread	DIN PIPE	Description
03030503	3/16	05	-3	7/16-20	12	AGJ DN05 7/16-20
03030603	1/4"	6	-4	7/16-20	12	AGJ DN06 7/16-20
03030612	1/4"	6	-4	1/2-20	14	AGJ DN06 1/2-20
03030613	1/4"	6	-4	9/16-18	17	AGJ DN06 9/16-18
03030812	5/16"	8	-5	1/2-20	14	AGJ DN08 1/2-20
03030813	5/16"	8	-5	9/16-18	17	AGJ DN08 9/16-18
03030820	5/16"	8	-5	3/4-16	19	AGJ DN08 3/4-16
03031013	3/8"	10	-6	9/16-18	17	AGJ DN10 9/16-18
03031020	3/8"	10	-6	3/4-16	19	AGJ DN10 3/4-16
03031015	3/8"	10	-6	7/8-14	24	AGJ DN10 7/8-14
03031220	1/2"	13	-8	3/4-16	19	AGJ DN13 3/4-16
03031215	1/2"	13	-8	7/8-14	24	AGJ DN13 7/8-14
03031217	1/2"	13	-8	1" 1/16-12	27	AGJ DN13 1 1/16-12
03031615	5/8"	16	-10	7/8-14	24	AGJ DN16 7/8-14
03031617	5/8"	16	-10	1" 1/16-12	27	AGJ DN16 1 1/16-12
03032017	3/4"	20	-12	1" 1/16-12	27	AGJ DN20 1 1/16-12
03032021	3/4"	20	-12	1" 3/16-12	32	AGJ DN20 1 3/16-12
03032023	3/4"	20	-12	1" 5/16-12	34	AGJ DN20 1 5/16-12
03032523	1"	25	-16	1" 5/16-12	34	AGJ DN25 1 5/16-12
03032527	1"	25	-16	1" 5/8-12	42	AGJ DN25 1 5/8-12
03033227	1 1/4"	32	-20	1" 5/8-12	42	AGJ DN32 1 5/8-12
03034029	1 1/2"	40	-24	1" 7/8-12	50	AGJ DN40 1 7/8-12
03035031	2"	50	-32	2" 1/2-12	60	AGJ DN50 2 1/2-12

AGJ
0303

Koncovky_fittings

Hadice_hoses

Ochrany_protections

DKJ priame, JIC závit vnútorný 74° kužel, SAE J516/J514
DKJ straight, JIC female thread 74° cone seat, SAE J516/J514

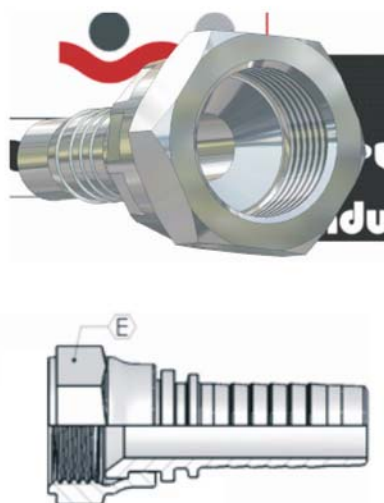

0300 DKJ	Hadica / Hose			Závit	TR DIN	Kľúč E	Označenie
Kód/Code	inch	DN	Size	Thread	DIN PIPE	Hex E	Description
03000503	3/16	05	-3	7/16-20		12	DKJ DN05 7/16-20
03000603	1/4"	6	-4	7/16-20		12	DKJ DN06 7/16-20
03000612	1/4"	6	-4	1/2-20		14	DKJ DN06 1/2-20
03000613	1/4"	6	-4	9/16-18		17	DKJ DN06 9/16-18
03000812	5/16"	8	-5	1/2-20		14	DKJ DN08 1/2-20
03000813	5/16"	8	-5	9/16-18		17	DKJ DN08 9/16-18
03000820	5/16"	8	-5	3/4-16		19	DKJ DN08 3/4-16
03001013	3/8"	10	-6	9/16-18		17	DKJ DN10 9/16-18
03001020	3/8"	10	-6	3/4-16		19	DKJ DN10 3/4-16
03001015	3/8"	10	-6	7/8-14		24	DKJ DN10 7/8-14
03001220	1/2"	13	-8	3/4-16		19	DKJ DN13 3/4-16
03001215	1/2"	13	-8	7/8-14		24	DKJ DN13 7/8-14
03001217	1/2"	13	-8	1" 1/16-12		27	DKJ DN13 1 1/16-12
03001615	5/8"	16	-10	7/8-14		24	DKJ DN16 7/8-14
03001617	5/8"	16	-10	1" 1/16-12		27	DKJ DN16 1 1/16-12
03002017	3/4"	20	-12	1" 1/16-12		27	DKJ DN20 1 1/16-12
03002021	3/4"	20	-12	1" 3/16-12		32	DKJ DN20 1 3/16-12
03002023	3/4"	20	-12	1" 5/16-12		34	DKJ DN20 1 5/16-12
03002523	1"	25	-16	1" 5/16-12		34	DKJ DN25 1 5/16-12
03002527	1"	25	-16	1" 5/8-12		42	DKJ DN25 1 5/8-12
03003227	1 1/4"	32	-20	1" 5/8-12		42	DKJ DN32 1 5/8-12
03004029	1 1/2"	40	-24	1" 7/8-12		50	DKJ DN40 1 7/8-12
03005031	2"	50	-32	2" 1/2-12		60	DKJ DN50 2 1/2-12

DKJ
0300

Note:



DKJ 45° koleno, JIC závit vnútorný 74° kužel, SAE J516/J514
DKJ 45° elbow, JIC female thread 74° cone seal, SAE J516/J514



0304 DKJ 45	Hadica / Hose			Závit	TR DIN	Klíč E	Označenie
Kód/Code	inch	DN	Size	Thread	DIN PIPE	Hex E	Description
03040503	3/16	05	-3	7/16-20		12	DKJ 45 DN05 7/16-20
03040603	1/4"	6	-4	7/16-20		12	DKJ 45 DN06 7/16-20
03040612	1/4"	6	-4	1/2-20		14	DKJ 45 DN06 1/2-20
03040613	1/4"	6	-4	9/16-18		17	DKJ 45 DN06 9/16-18
03040812	5/16"	8	-5	1/2-20		14	DKJ 45 DN08 1/2-20
03040813	5/16"	8	-5	9/16-18		17	DKJ 45 DN08 9/16-18
03040820	5/16"	8	-5	3/4-16		19	DKJ 45 DN08 3/4-16
03041013	3/8"	10	-6	9/16-18		17	DKJ 45 DN10 9/16-18
03041020	3/8"	10	-6	3/4-16		19	DKJ 45 DN10 3/4-16
03041015	3/8"	10	-6	7/8-14		24	DKJ 45 DN10 7/8-14
03041220	1/2"	13	-8	3/4-16		19	DKJ 45 DN13 3/4-16
03041215	1/2"	13	-8	7/8-14		24	DKJ 45 DN13 7/8-14
03041217	1/2"	13	-8	1" 1/16-12		27	DKJ 45 DN13 1 1/16-12
03041615	5/8"	16	-10	7/8-14		24	DKJ 45 DN16 7/8-14
03041617	5/8"	16	-10	1" 1/16-12		27	DKJ 45 DN16 1 1/16-12
03042017	3/4"	20	-12	1" 1/16-12		27	DKJ 45 DN20 1 1/16-12
03042021	3/4"	20	-12	1" 3/16-12		32	DKJ 45 DN20 1 3/16-12
03042023	3/4"	20	-12	1" 5/16-12		34	DKJ 45 DN20 1 5/16-12
03042523	1"	25	-16	1" 5/16-12		34	DKJ 45 DN25 1 5/16-12
03042527	1"	25	-16	1" 5/8-12		42	DKJ 45 DN25 1 5/8-12
03043227	1 1/4"	32	-20	1" 5/8-12		42	DKJ 45 DN32 1 5/8-12
03044029	1 1/2"	40	-24	1" 7/8-12		50	DKJ 45 DN40 1 7/8-12
03045031	2"	50	-32	2" 1/2-12		60	DKJ 45 DN50 2 1/2-12

DKJ 45
0304

Koncovky_fittings

Hadice_hoses

Ochrany_protections

DKJ 90° koleno, JIC závit vnútorný 74° kužel, SAE J516/J514
DKJ 90° elbow, JIC female thread 74° cone seat, SAE J516/J514



0309 DKJ 90	Hadica / Hose			Závit	TR DIN		Označenie
Kód/Code	inch	DN	Size	Thread	DIN PIPE		Description
03090503	3/16	05	-3	7/16-20		12	DKJ 90 DN05 7/16-20
03090603	1/4"	6	-4	7/16-20		12	DKJ 90 DN06 7/16-20
03090612	1/4"	6	-4	1/2-20		14	DKJ 90 DN06 1/2-20
03090613	1/4"	6	-4	9/16-18		17	DKJ 90 DN06 9/16-18
03090812	5/16"	8	-5	1/2-20		14	DKJ 90 DN08 1/2-20
03090813	5/16"	8	-5	9/16-18		17	DKJ 90 DN08 9/16-18
03090820	5/16"	8	-5	3/4-16		19	DKJ 90 DN08 3/4-16
03091013	3/8"	10	-6	9/16-18		17	DKJ 90 DN10 9/16-18
03091020	3/8"	10	-6	3/4-16		19	DKJ 90 DN10 3/4-16
03091015	3/8"	10	-6	7/8-14		24	DKJ 90 DN10 7/8-14
03091220	1/2"	13	-8	3/4-16		19	DKJ 90 DN13 3/4-16
03091215	1/2"	13	-8	7/8-14		24	DKJ 90 DN13 7/8-14
03091217	1/2"	13	-8	1" 1/16-12		27	DKJ 90 DN13 1 1/16-12
03091615	5/8"	16	-10	7/8-14		24	DKJ 90 DN16 7/8-14
03091617	5/8"	16	-10	1" 1/16-12		27	DKJ 90 DN16 1 1/16-12
03092017	3/4"	20	-12	1" 1/16-12		27	DKJ 90 DN20 1 1/16-12
03092021	3/4"	20	-12	1" 3/16-12		32	DKJ 90 DN20 1 3/16-12
03092023	3/4"	20	-12	1" 5/16-12		34	DKJ 90 DN20 1 5/16-12
03092523	1"	25	-16	1" 5/16-12		34	DKJ 90 DN25 1 5/16-12
03092527	1"	25	-16	1" 5/8-12		42	DKJ 90 DN25 1 5/8-12
03093227	1 1/4"	32	-20	1" 5/8-12		42	DKJ 90 DN32 1 5/8-12
03094029	1 1/2"	40	-24	1" 7/8-12		50	DKJ 90 DN40 1 7/8-12
03095031	2"	50	-32	2" 1/2-12		60	DKJ 90 DN50 2 1/2-12

DKJ 90
0309

Note:



ORS priame, vonkajší závit, SAE J1453
ORS straight, male thread, SAE J1453

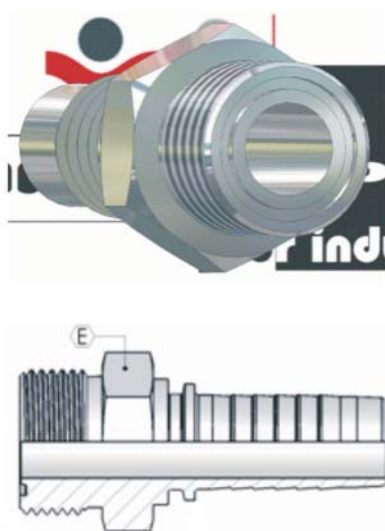

0403 ORS Kód/Code	Hadica / Hose		Závit Thread	TR DIN DIN PIPE	Klíúč E Hex E	Označenie Description
	inch	mm				
04030613	1/4"	6	-4	9/16-18	17	ORS DN 06 9/16-18
04030614	1/4"	6	-4	11/16-16	19	ORS DN 06 11/16-16
04030814	5/16"	8	-5	11/16-16	19	ORS DN 08 11/16-16
04031014	3/8"	10	-6	11/16-16	19	ORS DN 10 11/16-16
04031015	3/8"	10	-6	13/16-16	22	ORS DN 10 13/16-16
04031215	1/2"	12	-8	13/16-16	22	ORS DN 12 13/16-16
04031218	1/2"	12	-8	1"-14	27	ORS DN 12 1-14
04031221	1/2"	12	-8	1" 3/16-12	32	ORS DN 12 1" 3/16-12
04031618	5/8"	16	-10	1"-14	27	ORS DN 16 1-14
04031621	5/8"	16	-10	1" 3/16-12	32	ORS DN 16 1" 3/16-12
04032021	3/4"	20	-12	1" 3/16-12	32	ORS DN 20 1" 3/16-12
04032022	3/4"	20	-12	1" 7/16-12	41	ORS DN 20 1" 7/16-12
04032522	1"	25	-16	1" 7/16-12	41	ORS DN 25 1" 7/16-12
04033228	1 1/4"	32	-20	1" 11/16-12	46	ORS DN 32 1" 11/16-12
04034033	1 1/2"	40	-24	2"-12	55	ORS DN 40 2-12

ORS
0403

Koncovky_fittings

Hadice_hoses

Ochrany_protections

ORFS priame, závit vnútorný, SAE J516/J1453
ORFS straight, female thread, SAE J516/J1453

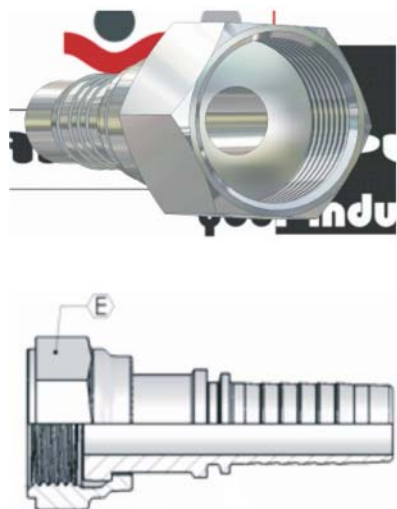

0400 ORFS Kód/Code	Hadica / Hose		Závit Thread	TR DIN DIN PIPE	Klíúč E Hex E	Označenie Description
	inch	mm				
04000613	1/4"	6	-4	9/16-18	17	ORFS DN 06 9/16-18
04000614	1/4"	6	-4	11/16-16	22	ORFS DN 06 11/16-16
04000814	5/16"	8	-5	11/16-16	22	ORFS DN 08 11/16-16
04001014	3/8"	10	-6	11/16-16	22	ORFS DN 10 11/16-16
04001015	3/8"	10	-6	13/16-16	24	ORFS DN 10 13/16-16
04001215	1/2"	12	-8	13/16-16	24	ORFS DN 12 13/16-16
04001218	1/2"	12	-8	1"-14	30	ORFS DN 12 1-14
04001221	1/2"	12	-8	1" 3/16-12	36	ORFS DN 12 1" 3/16-12
04001618	5/8"	16	-10	1"-14	30	ORFS DN 16 1-14
04001621	5/8"	16	-10	1" 3/16-12	36	ORFS DN 16 1" 3/16-12
04002018	3/4"	20	-12	1"-14	30	ORFS DN 20 1-14
04002021	3/4"	20	-12	1" 3/16-12	36	ORFS DN 20 1" 3/16-12
04002022	3/4"	20	-12	1" 7/16-12	41	ORFS DN 20 1" 7/16-12
04002521	1"	25	-16	1" 3/16-12	36	ORFS DN 25 1" 3/16-12
04002522	1"	25	-16	1" 7/16-12	41	ORFS DN 25 1" 7/16-12
04002528	1"	25	-16	1" 11/16-12	50	ORFS DN 25 1" 11/16-12
04003228	1 1/4"	32	-20	1" 11/16-12	50	ORFS DN 32 1" 11/16-12
04004033	1 1/2"	40	-24	2"-12	60	ORFS DN 40 2-12

ORFS
0400

crimped or slip on nut / zalisovaná alebo voľná matica

Note:



let's work us

ORFS 45° koleno, vnútorný závit, SAE J516/J1453
ORFS 45° elbow, female thread, SAE J516/J1453

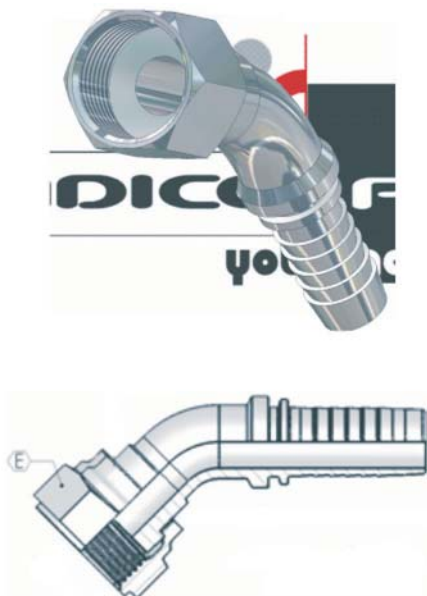

0404 ORFS 45 Kód/Code	Hadica / Hose			Závit Thread	TR DIN DIN PIPE	Klíč E Hex E	Označenie Description
	inch	mm	Size				
04040613	1/4"	6	-4	9/16-18		17	ORFS 45 DN 06 9/16-18
04040614	1/4"	6	-4	11/16-16		22	ORFS 45 DN 06 11/16-16
04040814	5/16"	8	-5	11/16-16		22	ORFS 45 DN 08 11/16-16
04041014	3/8"	10	-6	11/16-16		22	ORFS 45 DN 10 11/16-16
04041015	3/8"	10	-6	13/16-16		24	ORFS 45 DN 10 13/16-16
04041215	1/2"	12	-8	13/16-16		24	ORFS 45 DN 12 13/16-16
04041218	1/2"	12	-8	1"-14		30	ORFS 45 DN 12 1-14
04041221	1/2"	12	-8	1" 3/16-12		36	ORFS 45 DN 12 1" 3/16-12
04041618	5/8"	16	-10	1"-14		30	ORFS 45 DN 16 1-14
04041621	5/8"	16	-10	1" 3/16-12		36	ORFS 45 DN 16 1" 3/16-12
04042018	3/4"	20	-12	1"-14		30	ORFS 45 DN 20 1-14
04042021	3/4"	20	-12	1" 3/16-12		36	ORFS 45 DN 20 1" 3/16-12
04042022	3/4"	20	-12	1" 7/16-12		41	ORFS 45 DN 20 1" 7/16-12
04042521	1"	25	-16	1" 3/16-12		36	ORFS 45 DN 25 1" 3/16-12
04042522	1"	25	-16	1" 7/16-12		41	ORFS 45 DN 25 1" 7/16-12
04042528	1"	25	-16	1" 11/16-12		50	ORFS 45 DN 25 1" 11/16-12
04043228	1 1/4"	32	-20	1" 11/16-12		50	ORFS 45 DN 32 1" 11/16-12
04044033	1 1/2"	40	-24	2"-12		60	ORFS 45 DN 40 2-12

crimped or slip on nut / zalisovaná alebo voľná matica

ORFS 45
0404

Koncovky_fittings

Hadice_hoses

Ochran_y_protections

ORFS 90° koleno, závit vnútorný, SAE J516/J1453
ORFS 90° elbow, female thread, SAE J516/J1453

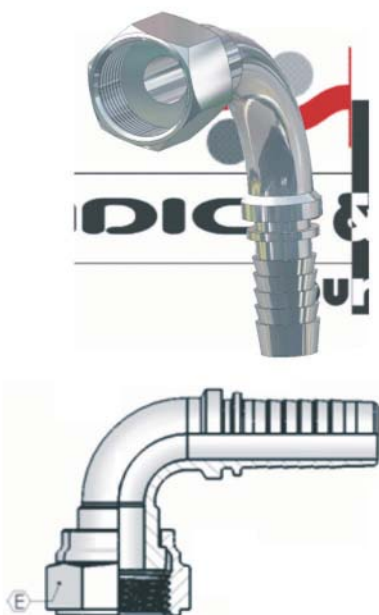

0409 ORFS 90 Kód/Code	Hadica / Hose			Závit Thread	TR DIN DIN PIPE	Klíč E Hex E	Označenie Description
	inch	mm	Size				
04090613	1/4"	6		9/16-18		17	ORFS 90 DN 06 9/16-18
04090614	1/4"	6		11/16-16		22	ORFS 90 DN 06 11/16-16
04090814	5/16"	8		11/16-16		22	ORFS 90 DN 08 11/16-16
04091014	3/8"	10		11/16-16		22	ORFS 90 DN 10 11/16-16
04091015	3/8"	10		13/16-16		24	ORFS 90 DN 10 13/16-16
04091215	1/2"	12		13/16-16		24	ORFS 90 DN 12 13/16-16
04091218	1/2"	12		1"-14		30	ORFS 90 DN 12 1-14
04091221	1/2"	12		1" 3/16-12		36	ORFS 90 DN 12 1" 3/16-12
04091618	5/8"	16		1"-14		30	ORFS 90 DN 16 1-14
04091621	5/8"	16		1" 3/16-12		36	ORFS 90 DN 16 1" 3/16-12
04092018	3/4"	20		1"-14		30	ORFS 90 DN 20 1-14
04092021	3/4"	20		1" 3/16-12		36	ORFS 90 DN 20 1" 3/16-12
04092022	3/4"	20		1" 7/16-12		41	ORFS 90 DN 20 1" 7/16-12
04092521	1"	25		1" 3/16-12		36	ORFS 90 DN 25 1" 3/16-12
04092522	1"	25		1" 7/16-12		41	ORFS 90 DN 25 1" 7/16-12
04092528	1"	25		1" 11/16-12		50	ORFS 90 DN 25 1" 11/16-12
04093228	1 1/4"	32		1" 11/16-12		50	ORFS 90 DN 32 1" 11/16-12
04094033	1 1/2"	40		2"-12		60	ORFS 90 DN 40 2-12

crimped or slip on nut / zalisovaná alebo voľná matica

ORFS 90
0409

Note:



ORFS 90° koleno, predĺžené, vnútorný závit, SAE J516/J1453
 ORFS 90° elbow, long, female thread, SAE J516/J1453

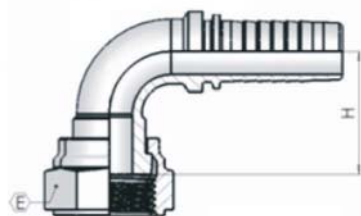

0408 ORFS 90L Kód/Code	Hadica / Hose			Závit	Elbow H	Klíúč E	Označenie
	inch	mm	Size	Thread	Elbow H	Hex E	Description
04080613	1/4"	6	-4	9/16-18	46	17	ORFS 90Long DN 06 9/16-18
04080814	5/16"	8	-5	11/16-16	54	22	ORFS 90Long DN 08 11/16-16
04081014	3/8"	10	-6	11/16-16	54	22	ORFS 90Long DN 10 11/16-16
04081015	3/8"	10	-6	13/16-16	54	24	ORFS 90Long DN 10 13/16-16
04081215	1/2"	12	-8	13/16-16	64	24	ORFS 90Long DN 12 13/16-16
04081218	1/2"	12	-8	1"-14	64	30	ORFS 90Long DN 12 1-14
04081618	5/8"	16	-10	1"-14	69	30	ORFS 90Long DN 16 1-14
04081621	5/8"	16	-10	1" 3/16-12	73	36	ORFS 90Long DN 16 1" 3/16-12
04082021	3/4"	20	-12	1" 3/16-12	96	36	ORFS 90Long DN 20 1" 3/16-12
04082022	3/4"	20	-12	1" 7/16-12	96	41	ORFS 90Long DN 20 1" 7/16-12
04082521	1"	25	-16	1" 3/16-12	114	36	ORFS 90Long DN 25 1" 3/16-12
04082522	1"	25	-16	1" 7/16-12	114	41	ORFS 90Long DN 25 1" 7/16-12

crimping or slip on nut / zalisovaná alebo voľná matica

ORFS 90
0408 long

Koncovky_fittings

Hadice_hoses

Ochrany_protections

SFL, priama príruha 3000psi, SAE J518, code 61
 SFL, straight flange 3000psi, SAE J518, code 61

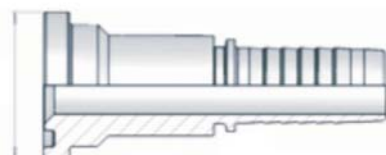

0500 SFL Kód/Code	Hadica / Hose			D	Flange	Označenie
	inch	mm	Size	mm	Príruba	Description
05001212	1/2	12	-8	30,2	1/2"	SFL DN12 1/2 D=30,2
05001220	1/2	12	-8	38,1	3/4"	SFL DN12 3/4 D=38,1
05001620	5/8	16	-10	38,1	3/4"	SFL DN16 3/4 D=38,1
05002020	3/4	20	-12	38,1	3/4"	SFL DN20 3/4 D=38,1
05002025	3/4	20	-12	44,5	1"	SFL DN20 1 D=44,5
05002525	1	25	-16	44,5	1"	SFL DN25 1 D=44,5
05002532	1	25	-16	51	1 1/4"	SFL DN25 1 1/4 D=51
05003232	1 1/4	32	-20	51	1 1/4"	SFL DN32 1 1/4 D=51
05003240	1 1/4	32	-20	60,3	1 1/2"	SFL DN32 1 1/2 D=60,3
05004040	1 1/2	40	-24	60,3	1 1/2"	SFL DN40 1 1/2 D=60,3
05004050	1 1/2	40	-24	71,4	2"	SFL DN40 2 D=71,4
05005050	2	50	-32	71,4	2"	SFL DN50 2 D=71,4
05005060	2	50	-32	84,3	2 1/2"	SFL DN50 2 1/2 D=84,3
05006060	2 3/8	60	-38	84,3	2 1/2"	SFL DN60 2 1/2 D=84,3
05006360	2 1/2	63	-40	84,3	2 1/2"	SFL DN63 2 1/2 D=84,3
05007676	3	76	-48	101,6	3"	SFL DN76 3 D=101,6

SFL
0500

Note:



let's work us

SFL 45° koleno 3000psi, SAE J518, code 61
SFL 45° elbow 3000psi, SAE J516 code 61

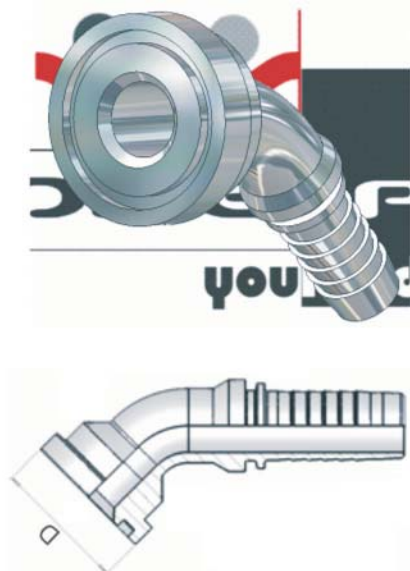

0504 SFL45	Hadica / Hose			D	Flange	Označenie
Kód/Code	inch	mm	Size	mm	Príruba	Description
05041212	1/2	12	-8	30,2	1/2"	SFL 45 DN12 1/2 D=30,2
05041220	1/2	12	-8	38,1	3/4"	SFL 45 DN12 3/4 D=38,1
05041620	5/8	16	-10	38,1	3/4"	SFL 45 DN16 3/4 D=38,1
05042020	3/4	20	-12	38,1	3/4"	SFL 45 DN20 3/4 D=38,1
05042025	3/4	20	-12	44,5	1"	SFL 45 DN20 1 D=44,5
05042525	1	25	-16	44,5	1"	SFL 45 DN25 1 D=44,5
05042532	1	25	-16	51	1 1/4"	SFL 45 DN25 1 1/4 D=51
05043232	1 1/4	32	-20	51	1 1/4"	SFL 45 DN32 1 1/4 D=51
05043240	1 1/4	32	-20	60,3	1 1/2"	SFL 45 DN32 1 1/2 D=60,3
05044040	1 1/2	40	-24	60,3	1 1/2"	SFL 45 DN40 1 1/2 D=60,3
05044050	1 1/2	40	-24	71,4	2"	SFL 45 DN40 2 D=71,4
05045050	2	50	-32	71,4	2"	SFL 45 DN50 2 D=71,4
05045060	2	50	-32	84,3	2 1/2"	SFL 45 DN50 2 1/2 D=84,3
05046060	2 3/8	60	-38	84,3	2 1/2"	SFL 45 DN60 2 1/2 D=84,3
05046360	2 1/2	63	-40	84,3	2 1/2"	SFL 45 DN63 2 1/2 D=84,3
05047676	3	76	-48	101,6	3"	SFL 45 DN76 3 D=101,6

22,5°, 30°, 60°, 67,5° elbows on request.
22,5°, 30°, 60°, 67,5° kolená na požiadanie.

SFL 45
0504

Koncovky_fittings

Hadice_hoses

Ochrany_protections

SFL 90° koleno 3000psi, SAE J518, code 61
SFL 90° elbow 3000psi, SAE J518, code 61

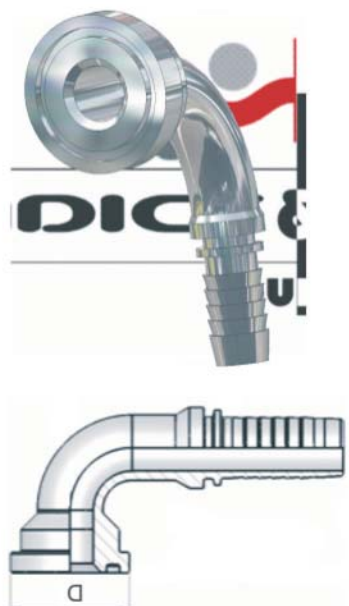

0509 SFL90	Hadica / Hose			D	Flange	Označenie
Kód/Code	inch	mm	Size	mm	Príruba	Description
05091212	1/2	12	-8	30,2	1/2"	SFL 90 DN12 1/2 D=30,2
05091220	1/2	12	-8	38,1	3/4"	SFL 90 DN12 3/4 D=38,1
05091620	5/8	16	-10	38,1	3/4"	SFL 90 DN16 3/4 D=38,1
05092020	3/4	20	-12	38,1	3/4"	SFL 90 DN20 3/4 D=38,1
05092025	3/4	20	-12	44,5	1"	SFL 90 DN20 1 D=44,5
05092525	1	25	-16	44,5	1"	SFL 90 DN25 1 D=44,5
05092532	1	25	-16	51	1 1/4"	SFL 90 DN25 1 1/4 D=51
05093232	1 1/4	32	-20	51	1 1/4"	SFL 90 DN32 1 1/4 D=51
05093240	1 1/4	32	-20	60,3	1 1/2"	SFL 90 DN32 1 1/2 D=60,3
05094040	1 1/2	40	-24	60,3	1 1/2"	SFL 90 DN40 1 1/2 D=60,3
05094050	1 1/2	40	-24	71,4	2"	SFL 90 DN40 2 D=71,4
05095050	2	50	-32	71,4	2"	SFL 90 DN50 2 D=71,4
05095060	2	50	-32	84,3	2 1/2"	SFL 90 DN50 2 1/2 D=84,3
05096060	2 3/8	60	-38	84,3	2 1/2"	SFL 90 DN60 2 1/2 D=84,3
05096360	2 1/2	63	-40	84,3	2 1/2"	SFL 90 DN63 2 1/2 D=84,3
05097676	3	76	-48	101,6	3"	SFL 90 DN76 3 D=101,6

22,5°, 30°, 60°, 67,5° elbows on request.
22,5°, 30°, 60°, 67,5° kolená na požiadanie.

SFL 90
0509

Note:



SFS, priama príruha 6000psi, SAE J518, code 62
SFS, straight flange 6000psi, SAE J518 code 62

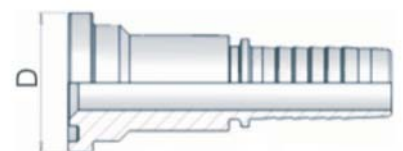

0520 SFS Kód/Code	Hadica / Hose			D mm	Flange Príruba	Označenie Description
	inch	mm	Size			
05201212	1/2	12	-8	31,8	1/2"	SFS DN12 1/2 D=31,7
05201220	1/2	12	-8	41,5	3/4"	SFS DN12 3/4 D=41,5
05201612	5/8	16	-10	31,8	1/2"	SFS DN16 1/2 D=31,8
05201620	5/8	16	-10	41,5	3/4"	SFS DN16 3/4 D=41,5
05202020	3/4	20	-12	41,5	3/4"	SFS DN20 3/4 D=41,5
05202025	3/4	20	-12	47,6	1"	SFS DN20 1 D=47,6
05202525	1	25	-16	47,6	1"	SFS DN25 1 D=47,6
05202532	1	25	-16	54	1 1/4"	SFS DN25 1 1/4 D=54
05203232	1 1/4	32	-20	54	1 1/4"	SFS DN32 1 1/4 D=54
05203240	1 1/4	32	-20	63,5	1 1/2"	SFS DN32 1 1/2 D=63,5
05204040	1 1/2	40	-24	63,5	1 1/2"	SFS DN40 1 1/2 D=63,5
05204050	1 1/2	40	-24	79,4	2"	SFS DN40 2 D=79,4
05205050	2	50	-32	79,4	2"	SFS DN50 2 D=79,4

SFS
0520

Koncovky_fittings

Hadice_hoses

Ochrany_protections

SFS 45° koleno 6000psi, SAE J518, code 62
SFS 45° elbow 6000psi, SAE J518, code 62

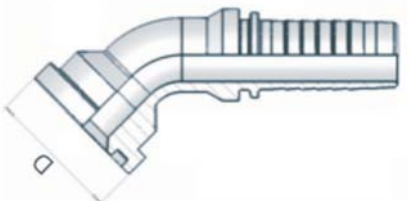

0524 SFS45 Kód/Code	Hadica / Hose			D mm	Flange Príruba	Označenie Description
	inch	mm	Size			
05241212	1/2	12	-8	31,7	1/2"	SFS 45 DN12 1/2 D=31,7
05241220	1/2	12	-8	41,5	3/4"	SFS 45 DN12 3/4 D=41,5
05241612	5/8	16	-10	31,8	1/2"	SFS 45 DN16 1/2 D=31,8
05241620	5/8	16	-10	41,5	3/4"	SFS 45 DN16 3/4 D=41,5
05242020	3/4	20	-12	41,5	3/4"	SFS 45 DN20 3/4 D=41,5
05242025	3/4	20	-12	47,6	1"	SFS 45 DN20 1 D=47,6
05242525	1	25	-16	47,6	1"	SFS 45 DN25 1 D=47,6
05242532	1	25	-16	54	1 1/4"	SFS 45 DN25 1 1/4 D=54
05243232	1 1/4	32	-20	54	1 1/4"	SFS 45 DN32 1 1/4 D=54
05243240	1 1/4	32	-20	63,5	1 1/2"	SFS 45 DN32 1 1/2 D=63,5
05244040	1 1/2	40	-24	63,5	1 1/2"	SFS 45 DN40 1 1/2 D=63,5
05244050	1 1/2	40	-24	79,4	2"	SFS 45 DN40 2 D=79,4
05245050	2	50	-32	79,4	2"	SFS 45 DN50 2 D=79,4

22,5°, 30°, 60°, 67,5° elbows on request.

22,5°, 30°, 60°, 67,5° kolená na požiadanie.

SFS 45
0524

Note:



SFS 90° koleno 6000psi, SAE J518, code 62
SFS 90° elbow 6000psi, SAE J518, code 62

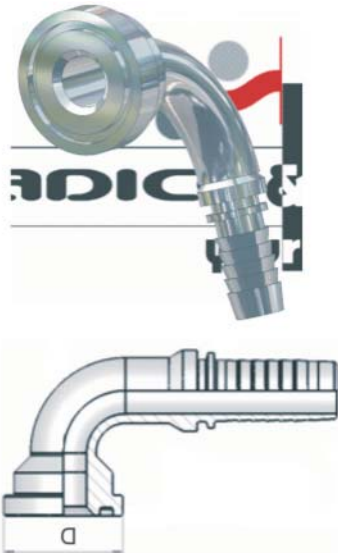

0529 SFS90 Kód/Code	Hadica / Hose			D mm	Flange Príruba	Označenie Description
	inch	mm	Size			
05291212	1/2	12	-8	31,7	1/2"	SFS 90 DN12 1/2 D=31,7
05291220	1/2	12	-8	41,5	3/4"	SFS 90 DN12 3/4 D=41,5
05291612	5/8	16	-10	31,8	1/2"	SFS 90 DN16 1/2 D=31,8
05291620	5/8	16	-10	41,5	3/4"	SFS 90 DN16 3/4 D=41,5
05292020	3/4	20	-12	41,5	3/4"	SFS 90 DN20 3/4 D=41,5
05292025	3/4	20	-12	47,6	1"	SFS 90 DN20 1 D=47,6
05292525	1	25	-16	47,6	1"	SFS 90 DN25 1 D=47,6
05292532	1	25	-16	54	1 1/4"	SFS 90 DN25 1 1/4 D=54
05293232	1 1/4	32	-20	54	1 1/4"	SFS 90 DN32 1 1/4 D=54
05293240	1 1/4	32	-20	63,5	1 1/2"	SFS 90 DN32 1 1/2 D=63,5
05294040	1 1/2	40	-24	63,5	1 1/2"	SFS 90 DN40 1 1/2 D=63,5
05294050	1 1/2	40	-24	79,4	2"	SFS 90 DN40 2 D=79,4
05295050	2	50	-32	79,4	2"	SFS 90 DN50 2 D=79,4

22,5°, 30°, 60°, 67,5° elbows on request.
22,5°, 30°, 60°, 67,5° kolená na požiadanie.

SFS 90
0529

Koncovky_fittings

Hadice_hoses

Ochrany_protections

Priama SUPERCAT príruha
Straight SUPERCAT flange



14,3mm

0540 SCAT Kód/Code	Hadica / Hose			D mm	Flange Príruba	Označenie Description
	inch	mm	Size			
05402020	3/4	20	-12	41,5	3/4"	SCAT DN20 3/4 D=41,5
05402025	3/4	20	-12	47,6	1"	SCAT DN20 1 D=47,6
05402525	1	25	-16	47,6	1"	SCAT DN25 1 D=47,6
05402532	1	25	-16	54	1 1/4"	SCAT DN25 1 1/4 D=54
05403232	1 1/4	32	-20	54	1 1/4"	SCAT DN32 1 1/4 D=54
05403240	1 1/4	32	-20	63,5	1 1/2"	SCAT DN32 1 1/2 D=63,5
05404040	1 1/2	40	-24	63,5	1 1/2"	SCAT DN40 1 1/2 D=63,5

SCAT
0540

Note:



let's work us

45° koleno SUPERCAT príruha 45° elbow SUPERCAT flange

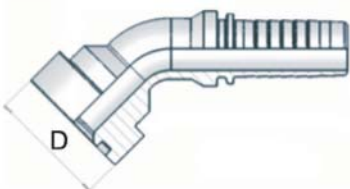

0544 SCAT45	Hadica / Hose			D	Flange	Označenie
Kód/Code	inch	mm	Size	mm	Príruba	Description
05442020	3/4	20	-12	41,5	3/4"	SCAT 45 DN20 3/4 D=41,5
05442025	3/4	20	-12	47,6	1"	SCAT 45 DN20 1 D=47,6
05442525	1	25	-16	47,6	1"	SCAT 45 DN25 1 D=47,6
05442532	1	25	-16	54	1 1/4"	SCAT 45 DN25 1 1/4 D=54
05443232	1 1/4	32	-20	54	1 1/4"	SCAT 45 DN32 1 1/4 D=54
05443240	1 1/4	32	-20	63,5	1 1/2"	SCAT 45 DN32 1 1/2 D=63,5
05444040	1 1/2	40	-24	63,5	1 1/2"	SCAT 45 DN40 1 1/2 D=63,5

22,5°, 30°, 60°, 67,5° elbows on request.
22,5°, 30°, 60°, 67,5° kolená na požiadanie.

SCAT 45
0544

Koncovky_fittings

Hadice_hoses

Ochrany_protections

90° koleno SUPERCAT príruha 90° elbow SUPERCAT flange

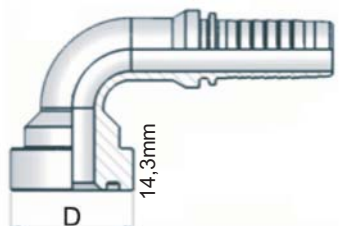

0549 SCAT90	Hadica / Hose			D	Flange	Označenie
Kód/Code	inch	mm	Size	mm	Príruba	Description
05492020	3/4	20	-12	41,5	3/4"	SCAT 90 DN20 3/4 D=41,5
05492025	3/4	20	-12	47,6	1"	SCAT 90 DN20 1 D=47,6
05492525	1	25	-16	47,6	1"	SCAT 90 DN25 1 D=47,6
05492532	1	25	-16	54	1 1/4"	SCAT 90 DN25 1 1/4 D=54
05493232	1 1/4	32	-20	54	1 1/4"	SCAT 90 DN32 1 1/4 D=54
05493240	1 1/4	32	-20	63,5	1 1/2"	SCAT 90 DN32 1 1/2 D=63,5
05494040	1 1/2	40	-24	63,5	1 1/2"	SCAT 90 DN40 1 1/2 D=63,5

22,5°, 30°, 60°, 67,5° elbows on request.
22,5°, 30°, 60°, 67,5° kolená na požiadanie.

SCAT 90
0549

Note:



JIS metrický závit vnútorný, 60° kužel JIS B 8362, KOMATSU
 JIS metric female thread, 60° cone seat JIS B8362, KOMATSU

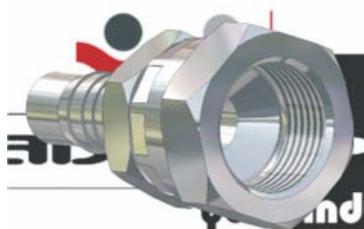

0170 Komatsu Kód/Code	Hadica / Hose			Závit Thread	Klíč E Hex E	Klíč E1 Hex E1	Označenie Description
	inch	DN	Size				
01700614	1/4	06	-4	M14x1,5	19	17	KOM DN06 M14x1,5
01700816	5/16	08	-5	M16x1,5	22	20	KOM DN08 M16x1,5
01701018	3/8	10	-6	M18x1,5	24	19	KOM DN10 M18x1,5
01701222	1/2	12	-8	M22x1,5	27	22	KOM DN12 M22x1,5
01701624	5/8	16	-10	M24x1,5	30	27	KOM DN16 M24x1,5
01702030	3/4	20	-12	M30x1,5	36	30	KOM DN20 M30x1,5
01702533	1	25	-16	M33x1,5	41	36	KOM DN25 M33x1,5
01703236	1 1/4	32	-20	M36x1,5	46	46	KOM DN32 M36x1,5
01704042	1 1/2	40	-24	M42x1,5	55	55	KOM DN40 M42x1,5

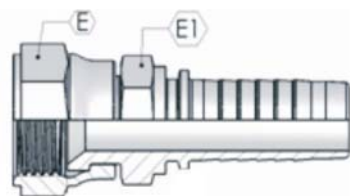

Komatsu
0170

Koncovky_fittings

Hadice_hoses

Ochrany_protections

JIS BSP vnútorný závit, 60° kužel, JIS B 8363, TOYOTA
 JIS BSP female thread, 60° cone seat JIS B 8364, TOYOTA

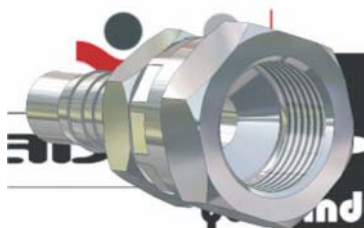

0175 Toyota Kód/Code	Hadica / Hose			Závit Thread	Klíč E Hex E	Klíč E1 Hex E1	Označenie Description
	inch	DN	Size				
01750606	1/4	06	-4	1/4-19	19	19	Toyota DN06 1/4-19
01751010	3/8	10	-6	3/8-19	22	22	Toyota DN10 3/8-19
01751212	1/2	12	-8	1/2-14	27	27	Toyota DN12 1/2-14
01752020	3/4	20	-12	3/4-14	32	32	Toyota DN20 3/4-14
01752525	1	25	-16	1-11	38	38	Toyota DN25 1-11

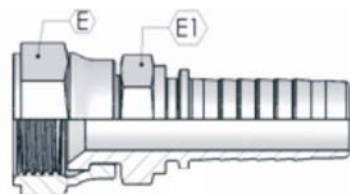

Toyota
0175

Note:



JIS BSP závit vnútorný, 60° kužeľ JIS B 8362, NISSAN
 JIS BSP female thread, 60° cone seat JIS B8362, NISSAN

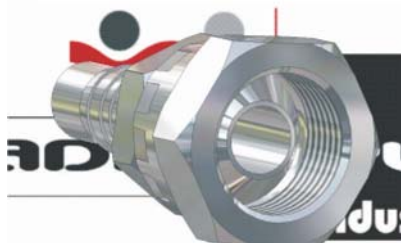

0240 Nissan	Hadica / Hose			Závit	Klíúč E	Klíúč E1	Označenie
Kód/Code	inch	DN	Size	Thread	Hex E	Hex E1	Description
02400606	1/4	06	-4	1/4-19	19	19	Nissan DN06 G1/4-19
02401010	3/8	10	-6	3/8-19	22	22	Nissan DN10 G3/8-19
02401212	1/2	12	-8	1/2-14	27	27	Nissan DN12 G1/2-14
02401620	5/8	16	-10	3/4-14	32	32	Nissan DN16 G3/4-14
02402020	3/4	20	-12	3/4-14	32	32	Nissan DN20 G3/4-14

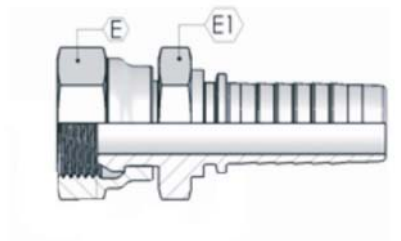

**Nissan
0240**

Koncovky_fittings

Hadice_hoses

Ochrany_protections

Note:



METRICKÉ BANJO (prietokové oko) DIN 7642 METRIC BANJO DIN 7642

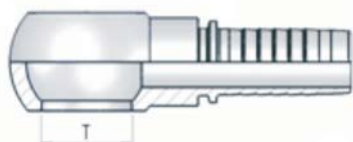

0160 Banjo M	Hadica / Hose			Závit	TR DIN	Klíč E	Označenie
Kód/Code	inch	DN	Size	Thread	DIN PIPE	Hex E	Description
01600510	3/16	05	-3	M10			BANJO DN05 M10
01600512	3/16	05	-3	M12x1,5			BANJO DN05 M12x1,5
01600514	3/16	05	-3	M14x1,5			BANJO DN05 M14x1,5
01600610	1/4	06	-4	M10			BANJO DN06 M10
01600612	1/4	06	-4	M12x1,5			BANJO DN06 M12x1,5
01600614	1/4	06	-4	M14x1,5			BANJO DN06 M14x1,5
01600616	1/4	06	-4	M16x1,5			BANJO DN06 M16x1,5
01600618	1/4	06	-4	M18x1,5			BANJO DN06 M18x1,5
01600814	5/16	08	-5	M14x1,5			BANJO DN08 M14x1,5
01600816	5/16	08	-5	M16x1,5			BANJO DN08 M16x1,5
01600818	5/16	08	-5	M18x1,5			BANJO DN08 M18x1,5
01601014	3/8	10	-6	M14x1,5			BANJO DN10 M14x1,5
01601016	3/8	10	-6	M16x1,5			BANJO DN10 M16x1,5
01601018	3/8	10	-6	M18x1,5			BANJO DN10 M18x1,5
01601020	3/8	10	-6	M20x1,5			BANJO DN10 M20x1,5
01601022	3/8	10	-6	M22x1,5			BANJO DN10 M22x1,5
01601218	1/2	12	-8	M18x1,5			BANJO DN12 M18x1,5
01601220	1/2	12	-8	M20x1,5			BANJO DN12 M20x1,5
01601222	1/2	12	-8	M22x1,5			BANJO DN12 M22x1,5
01601622	5/8	16	-10	M22x1,5			BANJO DN16 M22x1,5
01601624	5/8	16	-10	M24x1,5			BANJO DN16 M24x1,5
01601626	5/8	16	-10	M26x1,5			BANJO DN16 M26x1,5
01602026	3/4	20	-12	M26x1,5			BANJO DN20 M26x1,5
01602030	3/4	20	-12	M30x1,5			BANJO DN20 M30x1,5
01602530	1	25	-16	M30x1,5			BANJO DN25 M30x1,5

**Banjo M
0160**

Koncovky_fittings

Hadice_hoses

Ochrany_protections

METRICKÉ PRIETOKOVÁ SKRUTKA DIN 7643 METRIC BOLT DIN 7643



double bolt
dvojitá prietoková skrutka

0160 BOLT M	Hadica / Hose			Závit		Klíč E	Označenie
Kód/Code	inch	DN	Size	Thread		Hex E	Description
01630006				M6x1			BOLT M6x1
01630008				M8x1			BOLT M8x1
01630010				M10x1			BOLT M10x1
01630012				M12x1,5			BOLT M12x1,5
01630014				M14x1,5			BOLT M14x1,5
01630016				M16x1,5			BOLT M16x1,5
01630018				M18x1,5			BOLT M18x1,5
01630020				M20x1,5			BOLT M20x1,5
01630022				M22x1,5			BOLT M22x1,5
01630024				M24x1,5			BOLT M24x1,5
01630026				M26x1,5			BOLT M26x1,5
01630030				M30x1,5			BOLT M30x1,5

**BOLT M
0163**

Note:



let's work us

BSP BANJO (prietokové oko) BSP BANJO

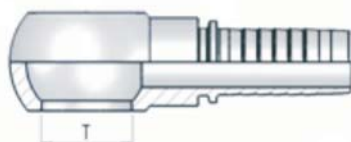

0230 BSP G	Hadica / Hose			Závit	Klíč E	Označenie
Kód/Code	inch	DN	Size	Thread	Hex E	Description
02300505	3/16	05	-3	1/8		BSP BANJO DN05 1/8
02300506	3/16	05	-3	1/4		BSP BANJO DN05 1/4
02300605	1/4	06	-4	1/8		BSP BANJO DN06 1/8
02300606	1/4	06	-4	1/4		BSP BANJO DN06 1/4
02300610	1/4	06	-4	3/8		BSP BANJO DN06 3/8
02300612	1/4	06	-4	1/2		BSP BANJO DN06 1/2
02300806	5/16	08	-5	1/4		BSP BANJO DN08 1/4
02300810	5/16	08	-5	3/8		BSP BANJO DN08 3/8
02300812	5/16	08	-5	1/2		BSP BANJO DN08 1/2
02301006	3/8	10	-6	1/4		BSP BANJO DN10 1/4
02301010	3/8	10	-6	3/8		BSP BANJO DN10 3/8
02301012	3/8	10	-6	1/2		BSP BANJO DN10 1/2
02301210	1/2	12	-8	3/8		BSP BANJO DN12 3/8
02301212	1/2	12	-8	1/2		BSP BANJO DN12 1/2
02301216	1/2	12	-8	5/8		BSP BANJO DN12 5/8
02301220	1/2	12	-8	3/4		BSP BANJO DN12 3/4
02301612	5/8	16	-10	1/2		BSP BANJO DN16 1/2
02301616	5/8	16	-10	5/8		BSP BANJO DN16 5/8
02301620	5/8	16	-10	3/4		BSP BANJO DN16 3/4
02302020	3/4	20	-12	3/4		BSP BANJO DN20 3/4
02302025	3/4	20	-12	1		BSP BANJO DN20 1
02302525	1	25	-16	1		BSP BANJO DN25 1
02302532	1	25	-16	1 1/4		BSP BANJO DN25 1 1/4
02303232	1 1/4	32	-20	1 1/4		BSP BANJO DN32 1 1/4
02303240	1 1/4	32	-20	1 1/2		BSP BANJO DN32 1 1/2
02304040	1 1/2	40	-24	1 1/2		BSP BANJO DN40 1 1/2
02304050	1 1/2	40	-24	2		BSP BANJO DN40 2
02305050	2	50	-32	2		BSP BANJO DN50 2

Banjo G
0230

Koncovky_fittings

Hadice_hoses

Ochrany_protections

BSP PRIETOKOVÁ SKRUTKA BSP BOLT



double bolt
dvojitá prietoková skrutka

0233 BOLT G	Hadica / Hose			Závit		Označenie
Kód/Code	inch	DN	Size	Thread		Description
02330005				1/8		BOLT 1/8
02330006				1/4		BOLT 1/4
02330010				3/8		BOLT 3/8
02330012				1/2		BOLT 1/2
02330016				5/8		BOLT 5/8
02330020				3/4		BOLT 3/4
02330025				1		BOLT 1
02330032				1 1/4		BOLT 1 1/4
02330040				1 1/2		BOLT 1 1/2
02330050				2		BOLT 2

BOLT G
0233

Note:



let's work us

Spojka Double Insert



0180 HS	Hadica / Hose			Označenie		
Kód/Code	inch	mm	Size	Description		
01800600	1/4	06	-4	HS 06		
01800800	5/16	08	-5	HS 08		
01801000	3/8	10	-6	HS 10		
01801200	1/2	12	-8	HS 12		
01801600	5/8	16	-10	HS 16		
01802000	3/4	20	-12	HS 20		
01802500	1	25	-16	HS 25		

elbows on request.
kolená na požiadanie.



Spojka
0180

Koncovky_fittings

Hadice_hoses

Ochran_y_protections

Koncovka pre čistiace zariadenia FK (Karcher) WashCleaner female FK (Karcher)



0190 FK	Hadica / Hose			Závit	Označenie	
Kód/Code	inch	mm	Size	Thread	Description	
01900822	5/16	08	-5	M22x1,5	FK DN08 M22x1,5	
01901022	3/8	10	-6	M22x1,5	FK DN10 M22x1,5	

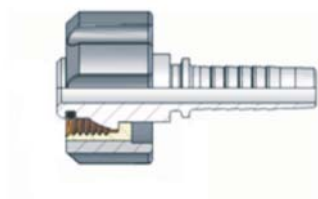

FK
0190

Note:



let's work us

STECK koncovka (banská koncovka) s O-kružkom a operným STECK (mining fitting) with O-ring and PA-ring



0193 Steck	Hadica / Hose			T		Označenie
Kód/Code	inch	mm	Size	T		Description
01930404	1/4	6	-4	15		Steck 6
01930606	3/8	10	-6	20		Steck 10
01930808	1/2	12	-8	24		Steck 12
01931212	3/4	20	-12	29		Steck 20
01931616	1	25	-16	39		Steck 25
01932020	1 1/4	32	-20	46		Steck 32
01932424	1 1/2	40	-24	55		Steck 40
01933232	2	51	-32	64		Steck 51

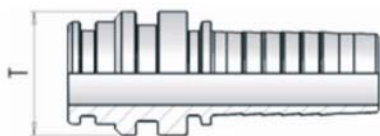

STECK
0193

Koncovky_fittings

Hadice_hoses

Ochrany_protections

**SAE polpríruba 3000psi code 61-SAE J518
SAE Split flange clamp 3000psi code 61-SAE J518**



0560 PP3000	Hadica / Hose			l	Príruba	Označenie
Kód/Code	inch	mm	Size	mm	Flange	Description
05601212	1/2	12	-8	54	1/2	PP3000-12
05602020	3/4	20	-12	65	3/4	PP3000-20
05602525	1	25	-16	70	1	PP3000-25
05603232	1 1/4	32	-20	80	1 1/4	PP3000-32
05604040	1 1/2	40	-24	94	1 1/2	PP3000-40
05605050	2	50	-32	102	2	PP3000-50



PP 3000
0560

Note:



let's work us

SAE polpríruba 6000psi code 62-SAE J518
SAE Split flange clamp 6000psi code 62-SAE J518



0565 PP6000	Hadica / Hose			l	Príruba		Označenie
Kód/Code	inch	mm	Size	mm	Flange		Description
05651212	1/2	12	-8	57	1/2		PP6000-12
05652020	3/4	20	-12	72	3/4		PP6000-20
05652525	1	25	-16	81	1		PP6000-25
05653232	1 1/4	32	-20	96	1 1/4		PP6000-32
05654040	1 1/2	40	-24	113	1 1/2		PP6000-40
05655050	2	50	-32	134	2		PP6000-50

PP 6000
0565

Koncovky_fittings

Hadice_hoses

Ochrany_protections

Note:



Objimka pre orezované hadice typ 4SH, 4SP, R12, R13, R15, INTERLOCK
Skive ferrule for 4SH, 4SP, R12, R13, R15

let's work us

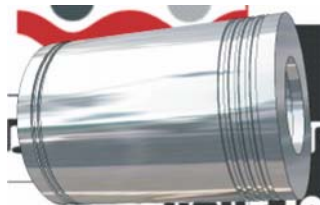

0680 4IX Kód/Code	Hadica / Hose						Označenie
	inch	mm	Size				Description
068020	3/4"	19	-12				OB 4IX DN19
068025	1"	25	-16				OB 4IX DN25
068032	1 1/4"	32	-20				OB 4IX DN32
068040	1 1/2"	40	-24				OB 4IX DN40
068050	2"	50	-32				OB 4IX DN50

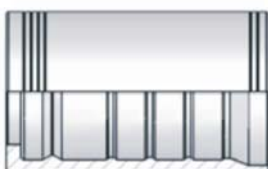

**4SH R13
0680**

Koncovky_fittings

Hadice_hoses

Ochrany_protections

Objimka pre orezované hadice typ R13, R15, INTERLOCK
Skive ferrule for R13, R15



0685 RIX Kód/Code	Hadica / Hose						Označenie
	inch	mm	Size				Description
068532	1 1/4"	32	-20				OB RIX DN32
068540	1 1/2"	40	-24				OB RIX DN40
068550	2"	50	-32				OB RIX DN50

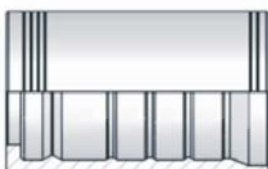

**R13 R15
0685**

Note:



CES priame, metrický závit vonkajší 24° kužel, ťažká rada, INTERLOCK
CES straight, male metric 24° cone seat, heavy series H.T.



0623 CES	Hadica / Hose			Závit	TR DIN	Klíúč E	Označenie
Kód/Code	inch	mm	Size	Thread	DIN PIPE	Hex E	Description
06232030	3/4	20	-12	M30x2		36	CES DN20 M30x2
06232036	3/4	20	-12	M36x2		41	CES DN20 M36x2
06232536	1	25	-16	M36x2		41	CES DN25 M36x2
06232542	1	25	-16	M42x2		50	CES DN25 M42x2
06233242	1 1/4	32	-20	M42x2		50	CES DN32 M42x2
06233252	1 1/4	32	-20	M52x2		60	CES DN32 M52x2
06234052	1 1/2	40	-24	M52x2		60	CES DN40 M52x2

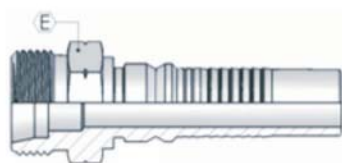

CES
0623

Koncovky_fittings Hadice_hoses Ochrany_protections

DKOS priame, metrický závit vnútorný 24° kužel, ťažká rada, INTERLOCK
DKOS straight, female metric 24° cone seat, heavy series H.T.



0620 DKOS	Hadica / Hose			Závit	TR DIN	Klíúč E	Označenie
Kód/Code	inch	mm	Size	Thread	DIN PIPE	Hex E	Description
06202030	3/4	20	-12	M30x2		36	DKOS DN20 M30x2
06202036	3/4	20	-12	M36x2		41	DKOS DN20 M36x2
06202536	1	25	-16	M36x2		41	DKOS DN25 M36x2
06202542	1	25	-16	M42x2		50	DKOS DN25 M42x2
06203242	1 1/4	32	-20	M42x2		50	DKOS DN32 M42x2
06203252	1 1/4	32	-20	M52x2		60	DKOS DN32 M52x2
06204052	1 1/2	40	-24	M52x2		60	DKOS DN40 M52x2

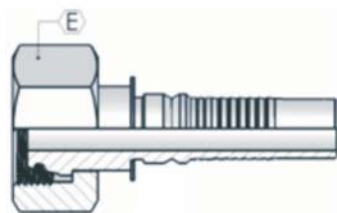

DKOS
0560

Note:



DKOS 45° koleno, metrický závit vnútorný 24° kužel', ťažka rada s O-krúžkom
DKOS 45° elbow, female metric 24° cone seat, heavy series H.T. with O-ring, INTERLOCK



0624 DKOS 45	Hadica / Hose			Závit	TR DIN	Kľúč E	Označenie
Kód/Code	inch	mm	Size	Thread	DIN PIPE	Hex E	Description
06242030	3/4	20	-12	M30x2		36	DKOS 45 DN20 M30x2
06242036	3/4	20	-12	M36x2		41	DKOS 45 DN20 M36x2
06242536	1	25	-16	M36x2		41	DKOS 45 DN25 M36x2
06242542	1	25	-16	M42x2		50	DKOS 45 DN25 M42x2
06243242	1 1/4	32	-20	M42x2		50	DKOS 45 DN32 M42x2
06243252	1 1/4	32	-20	M52x2		60	DKOS 45 DN32 M52x2
06244052	1 1/2	40	-24	M52x2		60	DKOS 45 DN40 M52x2

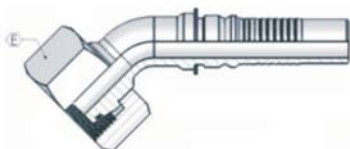

DKOS 45
0624

Koncovky_fittings

Hadice_hoses

Ochrany_protections

DKOS 90° koleno, metrický závit vnútorný 24° kužel', ťažka rada s O-krúžkom, INTERLOCK
DKOS 90° elbow, female metric 24° cone seat, heavy series H.T. with O-ring



0629 DKOS 90	Hadica / Hose			Závit	TR DIN	Kľúč E	Označenie
Kód/Code	inch	mm	Size	Thread	DIN PIPE	Hex E	Description
06292030	3/4	20	-12	M30x2		36	DKOS 90 DN20 M30x2
06292036	3/4	20	-12	M36x2		41	DKOS 90 DN20 M36x2
06292536	1	25	-16	M36x2		41	DKOS 90 DN25 M36x2
06292542	1	25	-16	M42x2		50	DKOS 90 DN25 M42x2
06293242	1 1/4	32	-20	M42x2		50	DKOS 90 DN32 M42x2
06293252	1 1/4	32	-20	M52x2		60	DKOS 90 DN32 M52x2
06294052	1 1/2	40	-24	M52x2		60	DKOS 90 DN40 M52x2

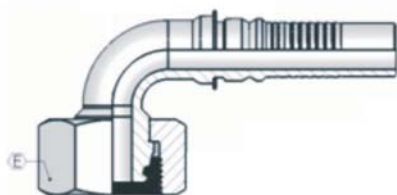

DKOS 90
0629

Note:



AGR, priama, BSP (BSPP) závit vonkajší 60° kužel, BS 5200, INTERLOCK
AGR, straight, BSP (BSPP) male 60° cone seat, BS 5200



0603 AGR	Hadica / Hose			Závit	TR DIN	Klíč E	Označenie
Kód/Code	inch	mm	Size	Thread	DIN PIPE	Hex E	Description
06032020	3/4	20	-12	G 3/4"		32	AGR DN20 3/4
06032525	1	25	-16	G 1"		38	AGR DN25 1
06032532	1	25	-16	G 1" 1/4		50	AGR DN25 1 1/4
06033232	1 1/4	32	-20	G 1" 1/4		50	AGR DN32 1 1/4
06034040	1 1/2	40	-24	G 1" 1/2		55	AGR DN40 1 1/2
06035050	2	50	-32	G 2"		70	AGR DN50 2

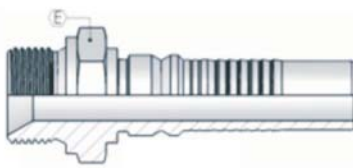

**AGR
0603**

Koncovky_fittings

Hadice_hoses

Ochrany_protections

AGR-K, priama, BSP (BSPT) kuželový závit vonkajší 60° kužel, BS 5200, INTERLOCK
AGR-K, straight, BSP (BSPT) tapered male 60° cone seat, BS 5200



0605 AGR-K	Hadica / Hose			Závit	TR DIN	Klíč E	Označenie
Kód/Code	inch	mm	Size	Thread	DIN PIPE	Hex E	Description
06052020	3/4	20	-12	G 3/4"		30	AGR-K DN20 3/4
06052525	1	25	-16	G 1"		36	AGR-K DN25 1
06053232	1 1/4	32	-20	G 1" 1/4		46	AGR-K DN32 1 1/4
06054040	1 1/2	40	-24	G 1" 1/2		50	AGR-K DN40 1 1/2
06055050	2	50	-32	G 2"		65	AGR-K DN50 2



**AGR-K
0605**

Note:



let's work us

DKOR, priama, BSP závit vnútorný 60° kužeľ, s O-krúžkom BS 5200,
DKOR, straight, BSP thread female 60° cone seat, with O-ring BS 5200, INTERLOCK

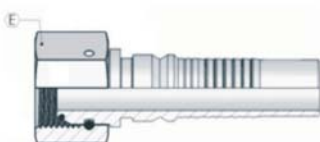

0600 DKOR	Hadica / Hose			Závit	TR DIN	Kľúč E	Označenie
Kód/Code	inch	mm	Size	Thread	DIN PIPE	Hex E	Description
06002020	3/4"	20	-12	3/4"		32	DKOR DN20 3/4
06002525	1"	25	-16	1"		38	DKOR DN25 1
06002532	1"	25	-16	1 1/4"		50	DKOR DN25 1 1/4
06003232	1 1/4"	32	-20	1 1/4"		50	DKOR DN32 1 1/4
06004040	1 1/2"	40	-24	1 1/2"		55	DKOR DN40 1 1/2
06005050	2"	50	-32	2"		70	DKOR DN50 2

trust wire nut or slip on nut / zaistená matica alebo voľná matica

Koncovky_fittings

Hadice_hoses

Ochran_y_protections

DKOR
0600

DKOR 45° koleno, BSP závit vnútorný 60° kužeľ, s O-krúžkom BS 5200,
DKOR 45° elbow, BSP thread female 60° cone seat, with O-ring BS 5200, INTERLOCK

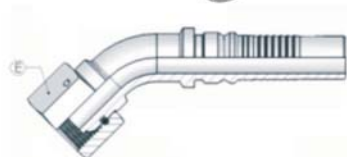

0604 DKOR 45	Hadica / Hose			Závit	TR DIN	Kľúč E	Označenie
Kód/Code	inch	mm	Size	Thread	DIN PIPE	Hex E	Description
06042020	3/4"	20	-12	3/4"		32	DKOR 45 DN20 3/4
06042525	1"	25	-16	1"		38	DKOR 45 DN25 1
06042532	1"	25	-16	1 1/4"		50	DKOR 45 DN25 1 1/4
06043232	1 1/4"	32	-20	1 1/4"		50	DKOR 45 DN32 1 1/4
06044040	1 1/2"	40	-24	1 1/2"		55	DKOR 45 DN40 1 1/2
06045050	2"	50	-32	2"		70	DKOR 45 DN50 2

trust wire nut or slip on nut / zaistená matica alebo voľná matica

Note:

DKOR 45
0604



DKOR 45° koleno, BSP závit vnútorný 60° kužel, s O-krúžkom BS 5200, DKOR 45° elbow, BSP thread female 60° cone seat, with O-ring BS 5200 INTERLOCK



0609 DKOR 90	Hadica / Hose			Závit	TR DIN	Klíč E	Označenie
Kód/Code	inch	mm	Size	Thread	DIN PIPE	Hex E	Description
06092020	3/4"	20	-12	3/4"		32	DKOR 90 DN20 3/4
06092525	1"	25	-16	1"		38	DKOR 90 DN25 1
06092532	1"	25	-16	1 1/4"		50	DKOR 90 DN25 1 1/4
06093232	1 1/4"	32	-20	1 1/4"		50	DKOR 90 DN32 1 1/4
06094040	1 1/2"	40	-24	1 1/2"		55	DKOR 90 DN40 1 1/2
06095050	2"	50	-32	2"		70	DKOR 90 DN50 2

trust wire nut or crimped nut / zaistená matica alebo zalisovaná matica

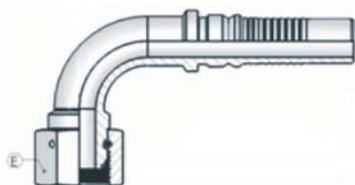

**DKOR 90
0609**

Koncovky_fittings

Hadice_hoses

Ochrany_protections

**AGJ priame, JIC závit vonkajší 74° kužel, SAE J516/J514, INTERLOCK
AGJ straight, JIC male thread 74° cone seat, SAE J516/J514**

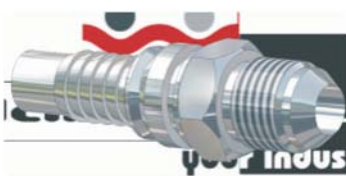

0613 AGJ	Hadica / Hose			Závit	TR DIN	Klíč E	Označenie
Kód/Code	inch	mm	Size	Thread	DIN PIPE	Hex E	Description
06132017	3/4"	20	-12	1" 1/16-12		27	AGJ DN20 1 1/16-12
06132023	3/4"	20	-12	1" 5/16-12		34	AGJ DN20 1 5/16-12
06132523	1"	25	-16	1" 5/16-12		34	AGJ DN25 1 5/16-12
06132527	1"	25	-16	1" 5/8-12		42	AGJ DN25 1 5/8-12
06133227	1 1/4"	32	-20	1" 5/8-12		42	AGJ DN32 1 5/8-12
06134029	1 1/2"	40	-24	1" 7/8-12		50	AGJ DN40 1 7/8-12
06135031	2"	50	-32	2" 1/2-12		65	AGJ DN50 2 1/2-12

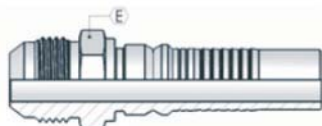

**AGJ
0613**

Note:



AGN, priama, NPTF závit vonkajší 60° kužeľ, INTERLOCK
AGN, straight, NPTF male 60° cone seat



0607 AGN	Hadica / Hose			Závit	TR DIN	Klíúč E	Označenie
Kód/Code	inch	mm	Size	Thread	DIN PIPE	Hex E	Description
06072020	3/4	20	-12	G 3/4"-14		27	AGN DN20 3/4 -14
06072525	1	25	-16	G 1"-11		36	AGN DN25 1-11
06072532	1	25	-16	G 1" 1/4-11		46	AGN DN25 1 1/4-11
06073232	1 1/4	32	-20	G 1" 1/4-11		46	AGN DN32 1 1/4-11
06074040	1 1/2	40	-24	G 1" 1/2-11		50	AGN DN40 1 1/2-11
06075050	2	50	-32	G 2"-11		65	AGN DN50 2-11



**AGN
0607**

Koncovky_fittings

Hadice_hoses

Ochrany_protections

DKJ priame, JIC závit vnútorný 74° kužeľ, SAE J516/J514, INTERLOCK
DKJ straight, JIC female thread 74° cone seat, SAE J516/J514



0610 DKJ	Hadica / Hose			Závit	TR DIN	Klíúč E	Označenie
Kód/Code	inch	mm	Size	Thread	DIN PIPE	Hex E	Description
06102017	3/4"	20	-12	1" 1/16-12		32	DKJ DN20 1 1/16-12
06102023	3/4"	20	-12	1" 5/16-12		41	DKJ DN20 1 5/16-12
06102523	1"	25	-16	1" 5/16-12		41	DKJ DN25 1 5/16-12
06102527	1"	25	-16	1" 5/8-12		50	DKJ DN25 1 5/8-12
06103227	1 1/4"	32	-20	1" 5/8-12		50	DKJ DN32 1 5/8-12
06104029	1 1/2"	40	-24	1" 7/8-12		55	DKJ DN40 1 7/8-12
06105031	2"	50	-32	2" 1/2-12		70	DKJ DN50 2 1/2-12

trust wire nut or crimped nut / zaistená matica alebo zalisovaná matica

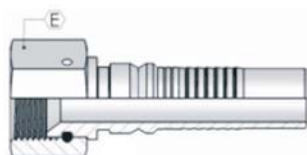

**DKJ
0610**

Note:



DKJ 45° koleno, JIC závit vnútorný 74° kužel, SAE J516/J514, INTERLOCK
DKJ 45° elbow, JIC female thread 74° cone seal, SAE J516/J514



0614 DKJ 45		Hadica / Hose		Závit	TR DIN	Klíč E	Označenie
Kód/Code	inch	mm	Size	Thread	DIN PIPE	Hex E	Description
06142017	3/4"	20	-12	1" 1/16-12		32	DKJ 45 DN20 1 1/16-12
06142023	3/4"	20	-12	1" 5/16-12		41	DKJ 45 DN20 1 5/16-12
06142523	1"	25	-16	1" 5/16-12		41	DKJ 45 DN25 1 5/16-12
06142527	1"	25	-16	1" 5/8-12		50	DKJ 45 DN25 1 5/8-12
06143227	1 1/4"	32	-20	1" 5/8-12		50	DKJ 45 DN32 1 5/8-12
06144029	1 1/2"	40	-24	1" 7/8-12		55	DKJ 45 DN40 1 7/8-12
06145031	2"	50	-32	2" 1/2-12		70	DKJ 45 DN50 2 1/2-12

trust wire nut or crimped nut / zaistená matica alebo zalisovaná matica

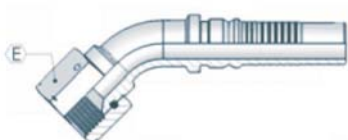

**DKJ 45
0614**

Koncovky_fittings

Hadice_hoses

Ochrany_protections

DKJ 90° koleno, JIC závit vnútorný 74° kužel, SAE J516/J514, INTERLOCK
DKJ 90° elbow, JIC female thread 74° cone seat, SAE J516/J514



0619 DKJ 90		Hadica / Hose		Závit	TR DIN	Klíč E	Označenie
Kód/Code	inch	mm	Size	Thread	DIN PIPE	Hex E	Description
06192017	3/4"	20	-12	1" 1/16-12		32	DKJ 90 DN20 1 1/16-12
06192023	3/4"	20	-12	1" 5/16-12		41	DKJ 90 DN20 1 5/16-12
06192523	1"	25	-16	1" 5/16-12		41	DKJ 90 DN25 1 5/16-12
06192527	1"	25	-16	1" 5/8-12		50	DKJ 90 DN25 1 5/8-12
06193227	1 1/4"	32	-20	1" 5/8-12		50	DKJ 90 DN32 1 5/8-12
06194029	1 1/2"	40	-24	1" 7/8-12		55	DKJ 90 DN40 1 7/8-12
06195031	2"	50	-32	2" 1/2-12		70	DKJ 90 DN50 2 1/2-12

trust wire nut or crimped nut / zaistená matica alebo zalisovaná matica

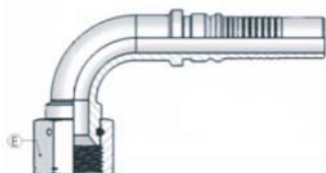

**DKJ 90
0619**

Note:



ORS priame, závit vonkajší, SAE J516/J1453, INTERLOCK
 ORS straight, male thread, SAE J516/J1453



0643 ORS	Hadica / Hose			Závit	TR DIN	Klíúč E	Označenie
Kód/Code	inch	mm	Size	Thread	DIN PIPE	Hex E	Description
06432021	3/4"	20	-12	1" 3/16-12		36	ORS DN 20 1" 3/16-12
06432522	1"	25	-16	1" 7/16-12		41	ORS DN 25 1" 7/16-12
06433228	1 1/4"	32	-20	1" 11/16-12		50	ORS DN 32 1" 11/16-12
06434033	1 1/2"	40	-24	2"-12		60	ORS DN 40 2-12

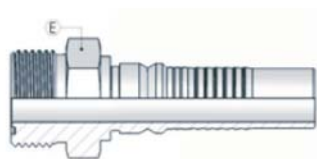

**ORS
0643**

Koncovky_fittings

Hadice_hoses

Ochrany_protections

ORFS priame, závit vnútorný, SAE J516/J1453, INTERLOCK
 ORFS straight, female thread, SAE J516/J1453

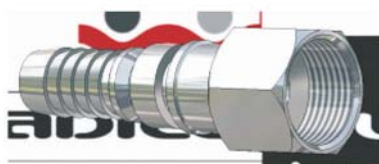

0640 ORFS	Hadica / Hose			Závit	TR DIN	Klíúč E	Označenie
Kód/Code	inch	mm	Size	Thread	DIN PIPE	Hex E	Description
06402021	3/4"	20	-12	1" 3/16-12		36	ORFS DN 20 1" 3/16-12
06402522	1"	25	-16	1" 7/16-12		41	ORFS DN 25 1" 7/16-12
06403228	1 1/4"	32	-20	1" 11/16-12		50	ORFS DN 32 1" 11/16-12
06404033	1 1/2"	40	-24	2"-12		60	ORFS DN 40 2-12

trust wire nut or crimped nut / zaistená matica alebo zalisovaná matica

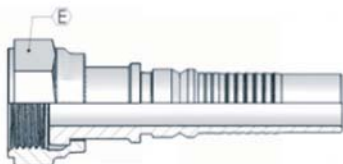

**ORFS
0640**

Note:



ORFS 45° koleno, vnútorný závit, SAE J516/J1453, INTERLOCK ORFS 45° elbow, female thread, SAE J516/J1453



0644 ORFS 45	Hadica / Hose			Závit	TR DIN	Klíúč E	Označenie
Kód/Code	inch	mm	Size	Thread	DIN PIPE	Hex E	Description
06442021	3/4"	20	-12	1" 3/16-12		36	ORFS 45 DN 20 1" 3/16-12
06442522	1"	25	-16	1" 7/16-12		41	ORFS 45 DN 25 1" 7/16-12
06443228	1 1/4"	32	-20	1" 11/16-12		50	ORFS 45 DN 32 1" 11/16-12
06444033	1 1/2"	40	-24	2"-12		60	ORFS 45 DN 40 2-12

trust wire nut or crimped nut / zaistená matica alebo zalisovaná matica

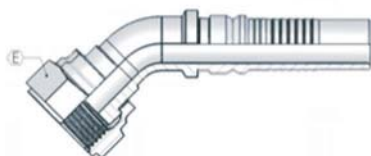

**ORFS 45
0614**

Koncovky_fittings

Hadice_hoses

Ochrany_protections

ORFS 90° koleno, vnútorný závit, SAE J516/J1453, INTERLOCK ORFS 90° elbow, female thread, SAE J516/J1453



0649 ORFS 90	Hadica / Hose			Závit	TR DIN	Klíúč E	Označenie
Kód/Code	inch	mm	Size	Thread	DIN PIPE	Hex E	Description
06492021	3/4"	20	-12	1" 3/16-12		36	ORFS 90 DN 20 1" 3/16-12
06492522	1"	25	-16	1" 7/16-12		41	ORFS 90 DN 25 1" 7/16-12
06493228	1 1/4"	32	-20	1" 11/16-12		50	ORFS 90 DN 32 1" 11/16-12
06494033	1 1/2"	40	-24	2"-12		60	ORFS 90 DN 40 2-12

trust wire nut or crimped nut / zaistená matica alebo zalisovaná matica

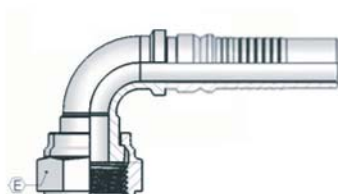

**ORFS 90
0640**

Note:



SFL, priama príruha 3000psi, SAE J518, code 61, INTERLOCK
SFL, straight flange 3000psi, SAE J518, code 61



0650 SFL	Hadica / Hose			D	Flange	Označenie
Kód/Code	inch	mm	Size	mm	Príruba	Description
06502020	3/4	20	-12	38,1	3/4"	SFL DN20 3/4 D=38,1
06502025	3/4	20	-12	44,5	1"	SFL DN20 1 D=44,5
06502525	1	25	-16	44,5	1"	SFL DN25 1 D=44,5
06502532	1	25	-16	51	1 1/4"	SFL DN25 1 1/4 D=51
06503232	1 1/4	32	-20	51	1 1/4"	SFL DN32 1 1/4 D=51
06503240	1 1/4	32	-20	60,3	1 1/2"	SFL DN32 1 1/2 D=60,3
06504040	1 1/2	40	-24	60,3	1 1/2"	SFL DN40 1 1/2 D=60,3
06504050	1 1/2	40	-24	71,4	2"	SFL DN40 2 D=71,4
06505050	2	50	-32	71,4	2"	SFL DN50 2 D=71,4



SFL
0650

Koncovky_fittings

Hadice_hoses

Ochrany_protections

SFL 45° koleno 3000psi, SAE J518, code 61, INTERLOCK
SFL 45° elbow 3000psi, SAE J516 code 61



0654 SFL 45	Hadica / Hose			D	Flange	Označenie
Kód/Code	inch	mm	Size	mm	Príruba	Description
06542020	3/4	20	-12	38,1	3/4"	SFL 45 DN20 3/4 D=38,1
06542025	3/4	20	-12	44,5	1"	SFL 45 DN20 1 D=44,5
06542525	1	25	-16	44,5	1"	SFL 45 DN25 1 D=44,5
06542532	1	25	-16	51	1 1/4"	SFL 45 DN25 1 1/4 D=51
06543232	1 1/4	32	-20	51	1 1/4"	SFL 45 DN32 1 1/4 D=51
06543240	1 1/4	32	-20	60,3	1 1/2"	SFL 45 DN32 1 1/2 D=60,3
06544040	1 1/2	40	-24	60,3	1 1/2"	SFL 45 DN40 1 1/2 D=60,3
06544050	1 1/2	40	-24	71,4	2"	SFL 45 DN40 2 D=71,4
06545050	2	50	-32	71,4	2"	SFL 45 DN50 2 D=71,4

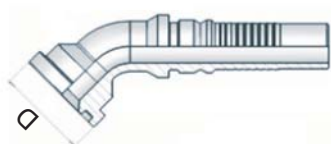

SFL 45
0654

Note:



SFL 90° koleno 3000psi, SAE J518, code 61, INTERLOCK
 SFL 90° elbow 3000psi, SAE J516 code 61



0659 SFL 90	Hadica / Hose			D	Flange	Označenie
Kód/Code	inch	mm	Size	mm	Príruba	Description
06592020	3/4	20	-12	38,1	3/4"	SFL 90 DN20 3/4 D=38,1
06592025	3/4	20	-12	44,5	1"	SFL 90 DN20 1 D=44,5
06592525	1	25	-16	44,5	1"	SFL 90 DN25 1 D=44,5
06592532	1	25	-16	51	1 1/4"	SFL 90 DN25 1 1/4 D=51
06593232	1 1/4	32	-20	51	1 1/4"	SFL 90 DN32 1 1/4 D=51
06593240	1 1/4	32	-20	60,3	1 1/2"	SFL 90 DN32 1 1/2 D=60,3
06594040	1 1/2	40	-24	60,3	1 1/2"	SFL 90 DN40 1 1/2 D=60,3
06594050	1 1/2	40	-24	71,4	2"	SFL 90 DN40 2 D=71,4
06595050	2	50	-32	71,4	2"	SFL 90 DN50 2 D=71,4

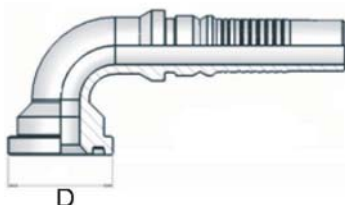

SFL 90
0659

Koncovky_fittings

Hadice_hoses

Ochrany_protections

SFS, priama príruba 6000psi, SAE J518, code 62, INTERLOCK
 SFS, straight flange 6000psi, SAE J518 code 62



0660 SFS	Hadica / Hose			D	Flange	Označenie
Kód/Code	inch	mm	Size	mm	Príruba	Description
06602020	3/4	20	-12	41,5	3/4"	SFS DN20 3/4 D=41,5
06602025	3/4	20	-12	47,6	1"	SFS DN20 1 D=47,6
06602525	1	25	-16	47,6	1"	SFS DN25 1 D=47,6
06602532	1	25	-16	54	1 1/4"	SFS DN25 1 1/4 D=54
06603232	1 1/4	32	-20	54	1 1/4"	SFS DN32 1 1/4 D=54
06603240	1 1/4	32	-20	63,5	1 1/2"	SFS DN32 1 1/2 D=63,5
06604040	1 1/2	40	-24	63,5	1 1/2"	SFS DN40 1 1/2 D=63,5
06604050	1 1/2	40	-24	79,4	2"	SFS DN40 2 D=79,4
06605050	2	50	-32	79,4	2"	SFS DN50 2 D=79,4

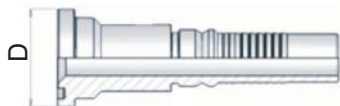

SFS
0660

Note:



SFS 45° koleno 6000psi, SAE J518, code 62, INTERLOCK
SFS 45° elbow 6000psi, SAE J516 code 62



0664 SFS 45	Hadica / Hose			D	Flange	Označenie
Kód/Code	inch	mm	Size	mm	Príruba	Description
06642020	3/4	20	-12	41,5	3/4"	SFS 45 DN20 3/4 D=41,5
06642025	3/4	20	-12	47,6	1"	SFS 45 DN20 1 D=47,6
06642525	1	25	-16	47,6	1"	SFS 45 DN25 1 D=47,6
06642532	1	25	-16	54	1 1/4"	SFS 45 DN25 1 1/4 D=54
06643232	1 1/4	32	-20	54	1 1/4"	SFS 45 DN32 1 1/4 D=54
06643240	1 1/4	32	-20	63,5	1 1/2"	SFS 45 DN32 1 1/2 D=63,5
06644040	1 1/2	40	-24	63,5	1 1/2"	SFS 45 DN40 1 1/2 D=63,5
06644050	1 1/2	40	-24	79,4	2"	SFS 45 DN40 2 D=79,4
06645050	2	50	-32	79,4	2"	SFS 45 DN50 2 D=79,4

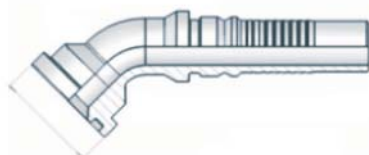

SFS 45
0664

Koncovky_fittings Hadice_hoses Ochrany_protections

SFS 90° koleno 6000psi, SAE J518, code 62, INTERLOCK
SFS 90° elbow 6000psi, SAE J516 code 62



0669 SFS 90	Hadica / Hose			D	Flange	Označenie
Kód/Code	inch	mm	Size	mm	Príruba	Description
06692020	3/4	20	-12	41,5	3/4"	SFS 90 DN20 3/4 D=41,5
06692025	3/4	20	-12	47,6	1"	SFS 90 DN20 1 D=47,6
06692525	1	25	-16	47,6	1"	SFS 90 DN25 1 D=47,6
06692532	1	25	-16	54	1 1/4"	SFS 90 DN25 1 1/4 D=54
06693232	1 1/4	32	-20	54	1 1/4"	SFS 90 DN32 1 1/4 D=54
06693240	1 1/4	32	-20	63,5	1 1/2"	SFS 90 DN32 1 1/2 D=63,5
06694040	1 1/2	40	-24	63,5	1 1/2"	SFS 90 DN40 1 1/2 D=63,5
06694050	1 1/2	40	-24	79,4	2"	SFS 90 DN40 2 D=79,4
06695050	2	50	-32	79,4	2"	SFS 90 DN50 2 D=79,4

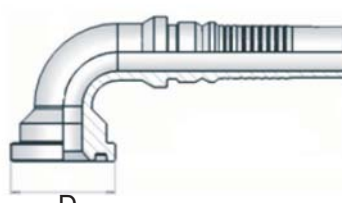

SFS 90
0669

Note:



Priama SUPERCAT príruha, INTERLOCK Straight SUPERCAT flange



0670 SCAT	Hadica / Hose			D	Flange	Označenie
Kód/Code	inch	mm	Size	mm	Príruba	Description
06702020	3/4	20	-12	41,5	3/4"	SCAT DN20 3/4 D=41,5
06702025	3/4	20	-12	47,6	1"	SCAT DN20 1 D=47,6
06702525	1	25	-16	47,6	1"	SCAT DN25 1 D=47,6
06702532	1	25	-16	54	1 1/4"	SCAT DN25 1 1/4 D=54
06703232	1 1/4	32	-20	54	1 1/4"	SCAT DN32 1 1/4 D=54
06704040	1 1/2	40	-24	63,5	1 1/2"	SCAT DN40 1 1/2 D=63,5

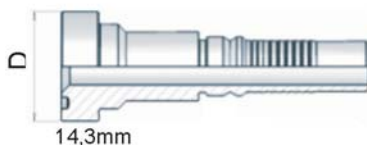

**SCAT
0670**

Koncovky_fittings Hadice_hoses Ochrany_protections

45° koleno SUPERCAT príruha, INTERLOCK 45° elbow SUPERCAT flange



0674 SCAT 45	Hadica / Hose			D	Flange	Označenie
Kód/Code	inch	mm	Size	mm	Príruba	Description
06742020	3/4	20	-12	41,5	3/4"	SCAT 45 DN20 3/4 D=41,5
06742025	3/4	20	-12	47,6	1"	SCAT 45 DN20 1 D=47,6
06742525	1	25	-16	47,6	1"	SCAT 45 DN25 1 D=47,6
06742532	1	25	-16	54	1 1/4"	SCAT 45 DN25 1 1/4 D=54
06743232	1 1/4	32	-20	54	1 1/4"	SCAT 45 DN32 1 1/4 D=54
06744040	1 1/2	40	-24	63,5	1 1/2"	SCAT 45 DN40 1 1/2 D=63,5

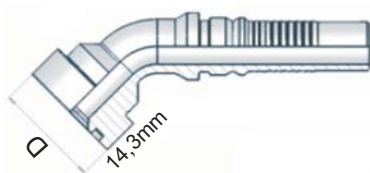

**SCAT 45
0674**

Note:



90° koleno SUPERCAT príruha, INTERLOCK
90° elbow SUPERCAT flange



0679 SCAT 90	Hadica / Hose			D	Flange	Označenie
Kód/Code	inch	mm	Size	mm	Príruba	Description
06792020	3/4	20	-12	41,5	3/4"	SCAT 90 DN20 3/4 D=41,5
06792025	3/4	20	-12	47,6	1"	SCAT 90 DN20 1 D=47,6
06792525	1	25	-16	47,6	1"	SCAT 90 DN25 1 D=47,6
06792532	1	25	-16	54	1 1/4"	SCAT 90 DN25 1 1/4 D=54
06793232	1 1/4	32	-20	54	1 1/4"	SCAT 90 DN32 1 1/4 D=54
06794040	1 1/2	40	-24	63,5	1 1/2"	SCAT 90 DN40 1 1/2 D=63,5

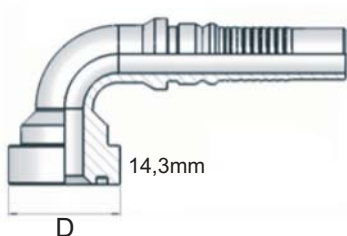

**SCAT 90
0679**

Koncovky_fittings

Hadice_hoses

Ochrany_protections

Note: